



ATSC

Version
04.00July
2005

TV Test Transmitter R&S®SFL

Digital signals for use in production

- ◆ Standard-conforming DVB and DTV signals
 - ◆ Wide output frequency range from 5 MHz to 1.1 GHz or 3.3 GHz
 - ◆ Wide output level range for transmission, receiver and components measurements
 - ◆ Operating parameters variable in a wide range
 - ◆ Internal test signals
 - ◆ Special signals and error signals for limit testing and troubleshooting
 - ◆ For use in production environments
 - Wear-free electronic attenuator
 - Fast setting times
 - ◆ Flexible input interfaces
 - SPI, ASI, SMPTE310
 - ◆ Input for I/Q signals
 - ◆ Noise source for accurate C/N measurement (option R&S®SFL-N)
 - ◆ Internal bit error ratio measurement facility (option R&S®SFL-K17)
 - ◆ Sweep mode for frequency and level
 - ◆ User-defined correction tables
- Various optimized models:
- ◆ R&S®SFL-T: antenna DVB-T/H
 - 2k, 4k and 8k COFDM
 - 5 MHz, 6 MHz, 7 MHz and 8 MHz bandwidth
 - Hierarchical coding
 - ◆ R&S®SFL-V: antenna ATSC
 - 8VSB
 - ◆ R&S®SFL-I: antenna ISDB-T
 - Mode 1/2/3 (2k, 4k, 8k)
 - Max. three layers (A, B, C)
 - 13 segments (settable for each layer)
 - ◆ R&S®SFL-C: cable DVB-C
 - Selectable (16QAM/32QAM/64QAM/128QAM/256QAM)
 - Data interleaver level 1 and level 2
 - ◆ R&S®SFL-J: cable J.83/B
 - Selectable (64QAM/256QAM)
 - ◆ R&S®SFL-S: satellite DVB-S/-DSNG
 - QPSK, 8PSK, 16QAM

ROHDE & SCHWARZ

A suitable model for each digital standard

R&S®SFL-T

- ◆ For digital standard DVB-T:
Terrestrial broadcasting via antenna
in line with EN300744
- ◆ For digital standard DVB-H:
Terrestrial mobile broadcasting via
antenna in line with EN302304

R&S®SFL-V

- ◆ For digital standard 8VSB:
Terrestrial broadcasting via antenna
in line with ATSC Doc. A/53 (8VSB)

R&S®SFL-I

- ◆ For digital standard ISDB-T:
Terrestrial broadcasting via antenna
in line with ARIB STD-B31, V1.0

R&S®SFL-C

- ◆ For digital standard DVB-C:
Broadcasting via cable in line with
ITU-T J.83/A, C and EN300429

R&S®SFL-J

- ◆ For digital standard J.83/B:
Broadcasting via cable in line with
ITU-T J.83/B

R&S®SFL-S

- ◆ For digital standards DVB-S and
DVB-DSNG:
Broadcasting via satellite in line
with EN300421/EN301210

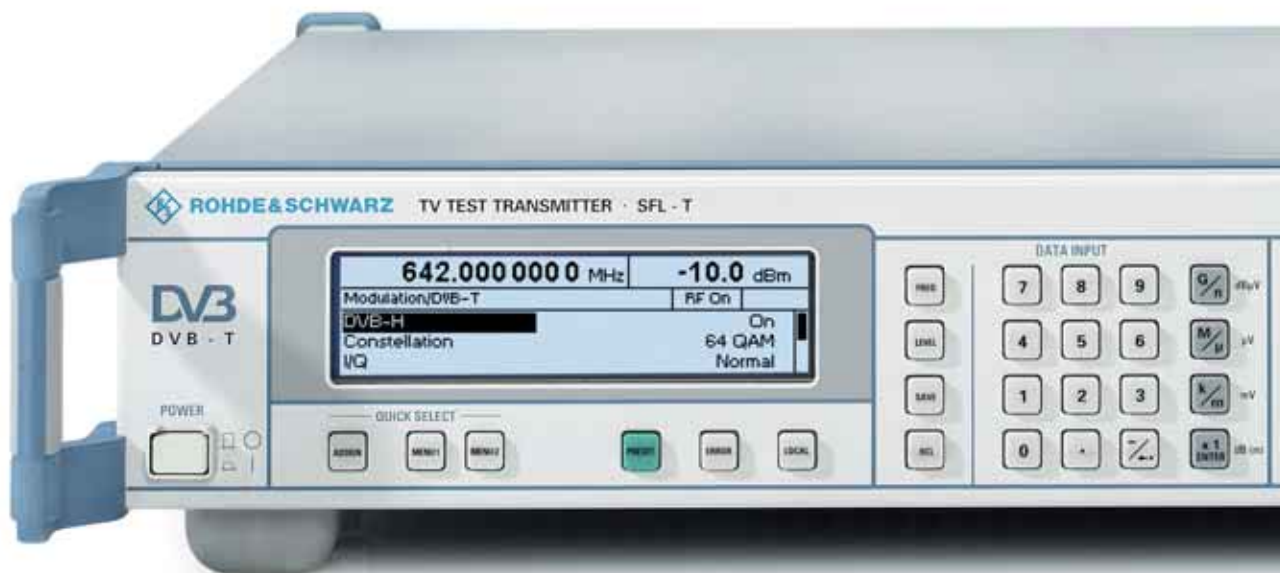

Key features

- ◆ Wide frequency range 5 MHz to 1.1 GHz or 3.3 GHz
- ◆ Large level range –140 dBm to 0 dBm
- ◆ Wear-free electronic attenuator
- ◆ Fast setting times
- ◆ Simple, user-friendly hardkey and softkey control
- ◆ Clearly arranged display with main parameters in headline
- ◆ Storage of instrument settings
- ◆ List function for automatic command sequence, e.g. measurement of frequency and amplitude response
- ◆ Online help
- ◆ IEC 625/IEEE 488 bus, RS-232-C
- ◆ Software update via RS-232-C



General

The TV Test Transmitter Family R&S®SFL is a complete solution for testing digital TV receivers and integrated receiver modules, as well as for testing digital TV links for broadcasting via terrestrial antennas and cable. It covers all main standards currently used worldwide as well as those to be introduced soon.

The standard-conforming test signals exhibit a high level of precision. To determine the full functionality and the performance of your products at their limits, the test signal parameters can be varied within a wide range and provided with predefined errors. Realistic transmission/reception conditions can be reproducibly simulated with the aid of the noise generator option.

Applications

The high signal quality and the versatile parameter variation capabilities make the R&S®SFL family ideally suited as a standard signal generator for use in production environments. The wide output frequency range allows testing beyond the limits defined by the relevant standard. The benefit of the large level range is that, on the one hand, the functional limits of LSI (large-scale integration) circuits can be quickly determined and recorded during production; on the other hand, it is easy to simulate a receive link for a TV receiver.

The operating parameters (e.g. roll-off, puncturing, QPSK mode, QAM mode, pilot level, interleaver level) can easily be varied even beyond the limits defined by the relevant standard. A number of special signals or signals with predefined errors are provided in order to determine the true functional limits or to quickly detect malfunctions; it is also possible to switch off signal characteristics defined in the standard or partial signal functions (e.g. modulation, individual carriers and groups of carriers, pilot).

Irrespective of the model, a sweep mode is available for the total frequency range, as well as an external I/Q input for signals with external coding.

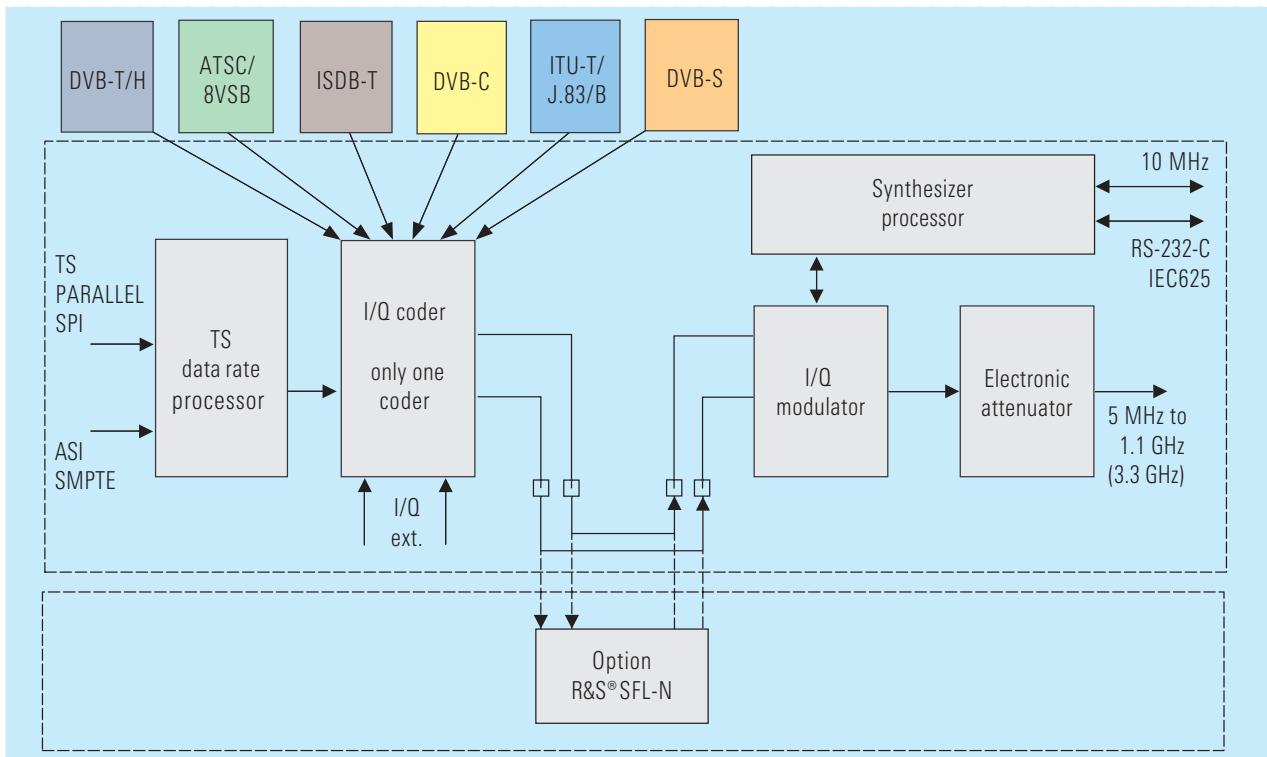

Block diagram of the TV Test Transmitter R&S® SFL

R&S®SFL-T/SFL-S/SFL-C

DVB: coding and mapping for antenna, satellite and cable

The DVB models of the TV Test Transmitter R&S®SFL encode the applied transport stream for terrestrial transmission via antenna or for satellite or cable transmission in line with standards and condition it so that I and Q (inphase and quadrature) signals are obtained. The R&S®SFL accepts MPEG-2 transport streams with a packet length of 188 or 204 bytes.

The input interfaces are synchronous parallel (TS parallel, SPI) and asynchronous serial (ASI). The input data rate and the symbol rate for the R&S®SFL-C and R&S®SFL-S are selectable. With the R&S®SFL-T, the channel bandwidths of 5 MHz, 6 MHz, 7 MHz and 8 MHz can be selected; the default settings can be varied.

Instead of the external transport data stream (DATA) being used, an internal data source can generate null transport stream packets (NULL TS PACKET, as defined in the DVB Measurement Guidelines), or an unpacketed random sequence (PRBS). The PRBS sequence is also available in packeted form in the null transport

stream packets (NULL PRBS PACKET). The R&S®SFL warns the user if the input signal fails, the set data rate does not match the incoming one or the USEFUL DATA RATE is too high.

DVB-T

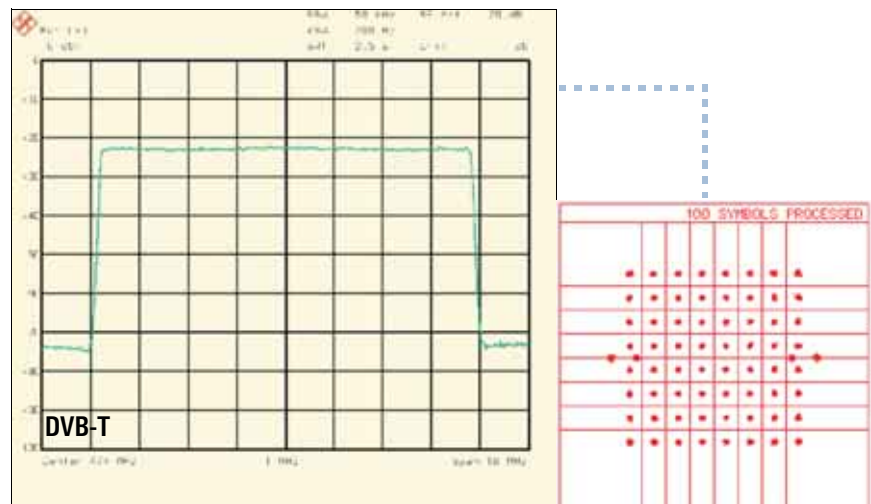

With DVB-T, hierarchical coding is also available. For this purpose, one of the two priorities is modulated with the external MPEG-2 transport stream, the other with the internal MPEG-2 signal NULL PRBS PACKET. Thus, only one external MPEG-2 transport stream is required and the two transport streams need not be synchronized. Since switching between the two priorities is easy, all simulations and measurements can be performed very quickly on both priorities, with the highly critical PRBS signal always assigned to the priority that is not currently being processed.

The input data stream is linked to a random sequence, ensuring that the signal energy is evenly distributed (energy dispersal). Energy dispersal can be switched off. The same applies to SYNC BYTE inversion. Following energy dispersal, a Reed-Solomon coder (204,188) is provided as an outer encoder for forward error correction (FEC).

Sixteen parity bytes are added to the unchanged 188 data bytes of each transport stream packet. These 16 parity bytes form the redundancy that allows eight errored bytes of a frame to be corrected by the receiver.

A convolutional interleaver distributes the data so that consecutive bits are separated. Burst errors occurring on the trans-

mission path are split up by the deinterleaver into single errors that can be corrected by the Reed-Solomon decoder. The interleaver, too, can be disabled.

Up to and including the convolutional interleaver, coding is identical for antenna (COFDM), satellite (QPSK, 8PSK, 16QAM) and cable (QAM) transmission. No further FEC coding is provided for cable transmission, as in this case interference due to noise, nonlinearities and interruptions is less likely than on satellite links or with antenna transmission. With cable transmission, mapping to the I and Q paths is performed next.

For terrestrial transmission via antenna and for satellite transmission, additional inner FEC coding is performed after the convolutional interleaver. The procedure, which is known as convolutional encoding, doubles the data rate. Puncturing is carried

out next, i.e. certain bits are left out in the transmission in accordance with a defined algorithm, so that the data rate is reduced again.

With DVB-S satellite transmission, mapping to the I and Q paths is performed at this point. Instead of the convolutional encoder (DVB-S), pragmatic trellis coding is used for DVB-DSNG satellite transmission.

For terrestrial transmission, the signal is made to pass through further FEC stages because of the inherently unfavorable propagation conditions: an inner bit interleaver (at the antenna end) and a symbol interleaver. Next, mapping is performed in accordance with the selected QPSK, 16QAM or 64QAM constellation. After insertion of the pilot and TPS (transmission parameter signaling) carriers in the frame adapter, conversion of the frequency domain to the time domain is effected by inverse fast Fourier transform, to a 1705 (2k), 3409 (4k) or 6817 (8k) carrier

DVB-S

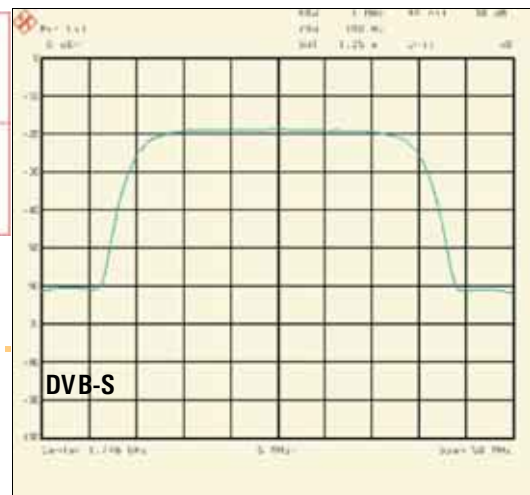
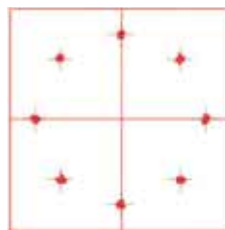

DVB-C

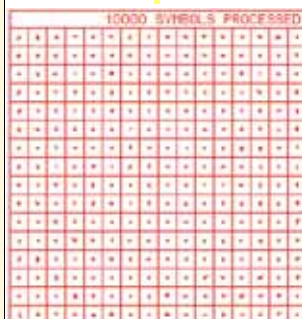
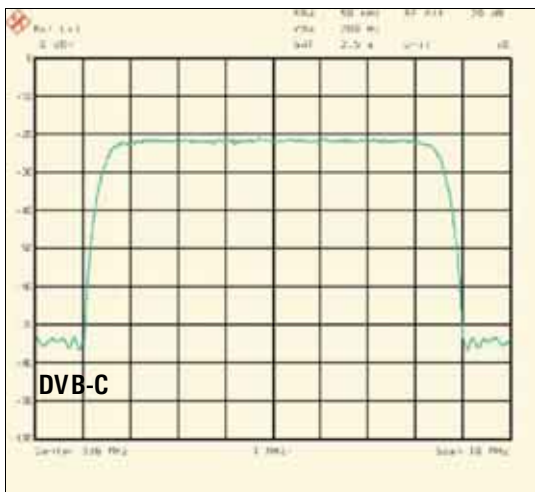

depending on the selected mode. As a last step, the guard interval is inserted.

Prior to modulation, the spectrum has to be limited by filtering. The roll-off factor (root cosine) can be varied for the R&S®SFL-C and R&S®SFL-S.

R&S®SFL-V

ATSC/8VSB: coding and mapping for antenna

The TV Test Transmitter R&S®SFL for 8VSB encodes the applied transport stream for terrestrial transmission via antenna in line with standards and processes it so that I and Q (inphase and quadrature) signals are obtained.

With 8VSB, the R&S®SFL accepts MPEG-2 transport streams with a packet length of 188 bytes. The input interfaces are synchronous parallel (TS parallel, SPI) and asynchronous serial (ASI and SMPTE310). When using the TS parallel input, an input data rate of $19.3926 \text{ Mbit/s} \pm 10\%$ can be attained.

The R&S®SFL warns the user if the input signal fails or if the USEFUL DATA RATE is too high. Instead of the external transport stream (DATA) being applied, an internal data source can generate null transport stream packets (NULL TS PACKET, NULL PRBS PACKET). A SYNC PRBS is implemented for bit error evaluation in receivers. An unpacketed random sequence

may also be selected. The PRBS sequence can be selected before (PRBS BEFORE TRELLIS) or after the trellis coder (PRBS AFTER TRELLIS). The PRBS sequence is also available in packeted form in the null transport stream packets (NULL PRBS PACKET).

Generation of the standard frame is followed by a randomizer which ensures that energy is evenly distributed in the channel (energy dispersal). The randomizer can be disabled. Following energy dispersal, a Reed-Solomon coder (208,188) is provided for forward error correction (FEC).

Twenty parity bytes are added to the unchanged 188 data bytes. Up to ten errors per segment can thus be corrected. A convolutional interleaver changes the position of the individual bytes so that consecutive bytes are separated. Burst errors occurring on the transmission path are split up by the receiver into single errors that can be corrected by the Reed-Solomon decoder. The interleaver can be disabled.

A trellis coder follows for further FEC. After the interleaver or trellis coder, the segment sync and the field sync pulses are inserted. The mapper assigns the relevant amplitude steps to the symbols. The pilot used by the receiver for synchronization is also added in the mapper. The pilot amplitude can be modified and switched off. Prior to modulation, the spectrum must be limited by appropriate filtering. The roll-off is permanently set to 0.115 (root cosine).

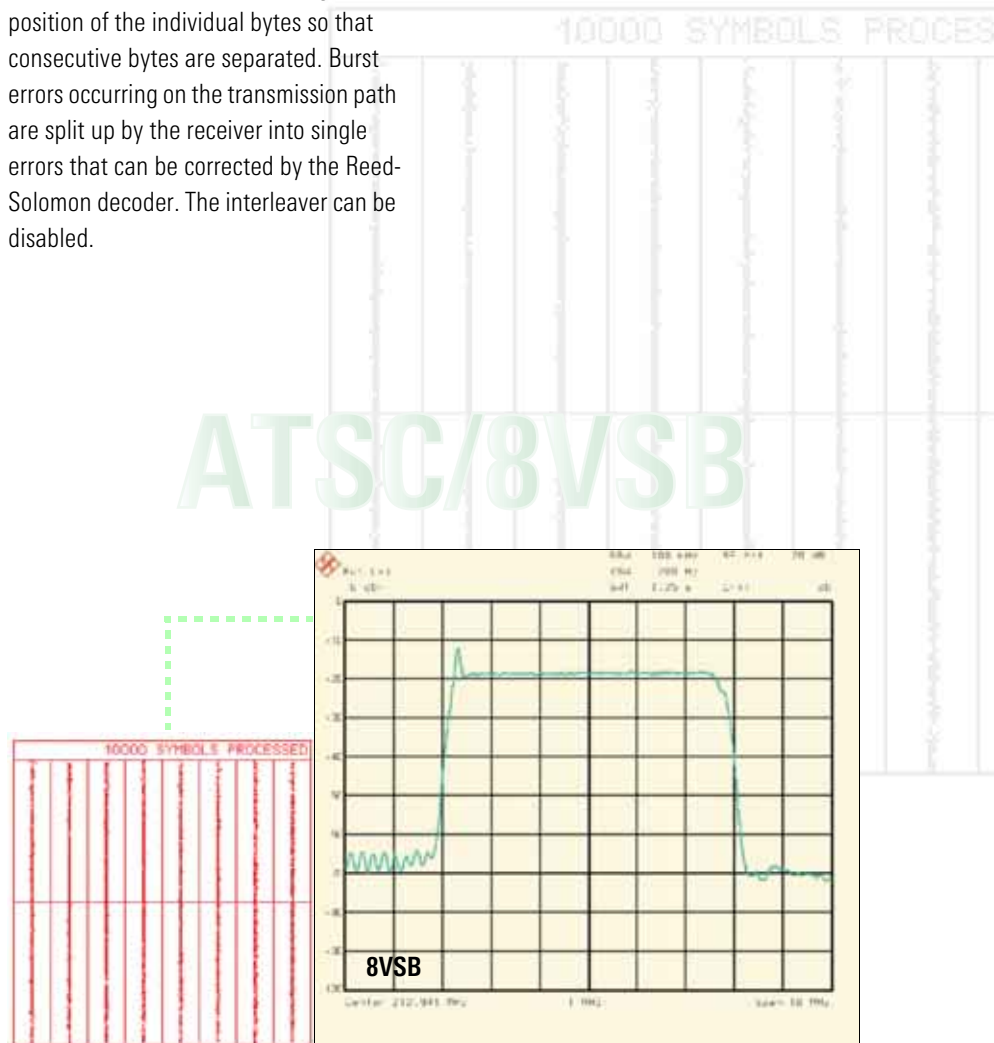

ISDB-T: coding und mapping for antenna

The ISDB-T (terrestrial integrated services digital broadcasting) coder of the R&S®SFL encodes an MPEG-2 data stream in line with standards for transmission in the RF channel.

The transport stream first passes through the outer coder where each transport stream packet undergoes Reed-Solomon encoding. The receiver is thus able to correct up to eight erroneous bytes in one transport stream packet. The error-protected data stream then passes through a splitter which divides the transport stream packets between as many as three hierarchical layers. Next, the energy dispersal module adds a pseudo random binary sequence (PRBS) to the data stream to ensure a sufficient number of binary changes.

Depending on the two transmission parameters "modulation" and "code rate", the data stream delay in each of the three paths will be different as a result of bitwise interleaving in the transmitter and deinterleaving in the receiver. To minimize the effort required at the receiver end, delay adjustment is performed in the coder. The three data streams are delayed in such a manner that subsequent delay differences can be compensated in advance. Bitwise interleaving separates initially adjacent bytes, making the signal resistant to burst errors.

The convolutional coder with integrated puncturer adds further redundancy to the data stream to permit error correction in the receiver (Viterbi decoder). The code rate can be selected in line with the required transmission characteristics of the system.

Modulation is then performed. It includes bitwise interleaving with delay adjustment and mapping to the modulation constellation diagram. Possible constellations with ISDB-T are DQPSK, QPSK, 16QAM and 64QAM. The constellation can be selected in line with the required transmission characteristics of the system. Appropriate bitwise interleaving and delay adjustment are automatically selected.

The hierarchical data stream is then synthesized. For this purpose, the complex mapped data from each of the as many as three paths is added to form a serial data stream.

Symbol-by-symbol time interleaving follows synthesis. This is an intra-segment time interleaver whose depth can be set separately for each layer.

Delay adjustment is also performed in the time interleaver, again to compensate for different delays in the paths.

Frequency interleaving then scrambles the data within an OFDM symbol, i.e. in the frequency domain. First, an inter-segment interleaver is used between the OFDM segments that have the same modulation, followed by an intra-segment interleaver that rotates the data within a

segment. Finally, the data passes through an intra-segment randomizer that shifts the data within a segment to quasi-random positions. OFDM framing is performed next. Frames are formed from 204 OFDM symbols by adding pilot carriers. Depending on the mode and the selected modulation, pilot carriers are inserted in the data stream at different positions. Moreover, TMCC (transmission and multiplexing configuration control) carriers and auxiliary channel (AC) carriers are added. The data that has been generated now undergoes inverse fast Fourier transform (IFFT) to transfer it from the frequency domain to the time domain as is usual with OFDM modulation. The length of IFFT depends on the selected ISDB-T mode and can be 2k, 4k or 8k.

IFFT is followed by the insertion of the guard interval. This guard interval extends the OFDM symbols by a specific factor (1/4, 1/8, 1/16 or 1/32). This measure has a positive effect on the receiving characteristics of multipath propagation and mobile reception.

ISDB-T

ITU-T J.83/B: coding and mapping for cable

The symbol rate of the coder and thus the output signal bandwidth can be varied in a wide range of $\pm 10\%$ of the standard symbol rate.

Internal test sequences (NULL TS PACKETS, NULL PRBS PACKETS, SYNC PRBS) can be substituted for the applied data signal and are helpful for bit error measurements.

Processing stages of the coder: The coder receives an MPEG-2-coded standard-conforming input data stream with a packet length of 188 bytes.

J.83/B specifies additional error control at the transport stream level. The sync byte is replaced by the sliding checksum calculated from the content of the transport stream packets. In addition to packet synchronization, the receiver can thus detect any errors that occur.

The subsequent FEC layer processes the data without synchronization to the transport structure.

In line with J.83/B, FEC consists of four processing layers that allow reliable data transport via the cable transmission channel. These layers are:

- ◆ Reed-Solomon coding (128, 122) for outer error correction, allowing up to three symbols in one Reed-Solomon block to be corrected
- ◆ A subsequent convolutional interleaver that uniformly disperses consecutive symbols across the data stream and so protects the data stream against burst-type impairments
- ◆ A randomizer that ensures uniform power density in the channel
- ◆ Trellis coding for inner error correction, involving convolutional encoding of data and inserting of defined redundant information into the symbols

Randomizer, interleaver and Reed-Solomon coder can be disabled, which is very helpful in the development of receivers.

All the interleaver modes defined in the J.83/B specification are implemented (level 1 and level 2) and allow flexible adaptation of the system to different transmission conditions.

FEC frame generation: With 64QAM, a frame sync trailer is inserted after 60 Reed-Solomon packets to form a FEC frame (with 256QAM after 88 Reed-Solomon packets).

The frame sync trailer is used for FEC synchronization in the receiver and transmits coded information about the current interleaver configuration. The trailer is inserted immediately ahead of the trellis coder.

The trellis coder for 64QAM performs differential and convolutional encoding with subsequent puncturing (CR = 14/15). The output symbol width of the trellis coder is 6 bits which reflects the modulation order of 64QAM.

The differential coder/convolutional encoder in the trellis block for 256QAM is of identical design, but generates an overall code rate of 19/20. The output symbol width is 8 bits, corresponding to 256 constellation points.

After the mapper and before modulation, the output spectrum is pulse-shaped and band-limited by a digital $\sqrt{\text{cos}}$ roll-off filter. The roll-off is 0.18 with 64QAM and 0.12 with 256QAM in line with the standard.

ITU-T/J.83B

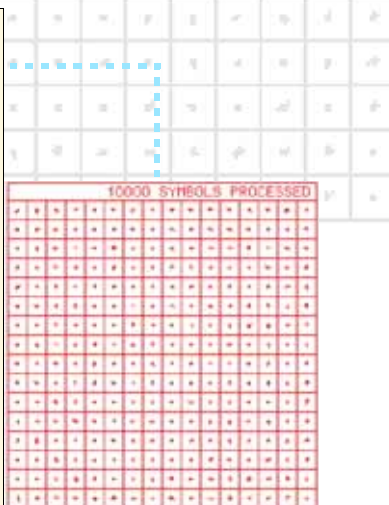
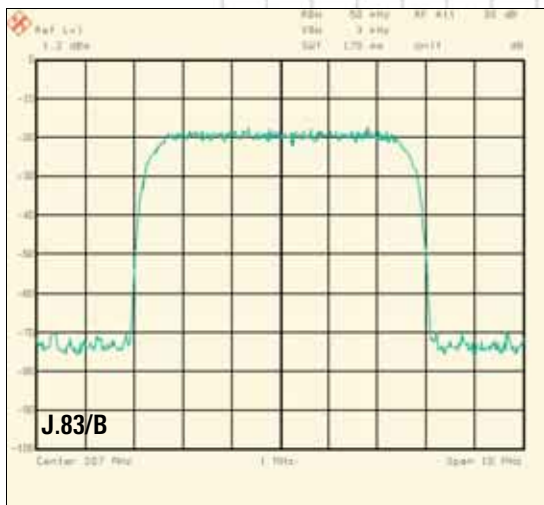

Data inputs

The R&S®SFL has a suitable data input for every application. Via the TS PARALLEL (with LVDS format) and SMPTE310 inputs, the input signal is passed on to the coder without modification. The symbol rate directly depends on the input data rate. The SPI and ASI inputs adapt the signal prior to coding to the desired symbol rate with the aid of the stuffing function.

These inputs allow setting of the symbol rate independently of the input data rate, so that the input data rate is independent of the DVB-T/H and 8VSB channel bandwidth. To this effect, all null packets are removed. The data rate required for a specific symbol rate or bandwidth is obtained by stuffing, i.e. by inserting new

null packets. The PCR (program clock reference) values are adapted. A built-in synthesizer ensures an accurate data clock at all inputs. For synchronization to a receiver, an external clock can be applied to the ASI and SPI inputs instead of the internal clock.

I/Q modulation

In the I/Q modulator, the orthogonal I and Q components of the RF signal are controlled in amplitude and phase by the analog I and Q signals from the coder. The two RF components are added to form an output signal that can be amplitude- and phase-modulated as required. Assignment of I and Q components can be interchanged in the R&S®SFL so that an inverted RF signal is obtained. High

demands are placed on the I/Q modulator, particularly regarding high-order quadrature amplitude modulation.

The internal calibration of the R&S®SFL ensures that the I and Q paths have identical gain, the phase is exactly 90° and carrier suppression is at least 50 dB. Non-ideal behavior of an I/Q modulator can be simulated by detuning amplitude, I/Q imbalance, phase error and carrier leakage in the R&S®SFL. As a result, bit errors are produced that allow quality assessment of receivers and demodulators.



Rear view of the R&S®SFL

Noise generator (option R&S®SFL-N)

A TV test transmitter is normally used to generate signals that are as ideal as possible. With receiver tests, however, it is necessary to simulate transmit and receive conditions. For this purpose, the option R&S®SFL-N was developed.

The R&S®SFL-N option is screw-connected to the base unit and electrically connected on the rear panel.

By using a noise generator which provides additive white Gaussian noise (AWGN), the R&S®SFL output signal can be superimposed. The carrier-to-noise (C/N) ratio can be varied over a wide

range while maintaining high resolution/accuracy. Precise sensitivity measurements of receiver circuits with a defined C/N ratio are thus feasible, for example. Digital signal processing (I and Q signals) in the baseband is used to generate the AWGN signal.

High accuracy and excellent reproducibility of the measurements are thus ensured:

- ◆ Superimposed noise signal (AWGN)
- ◆ Variable C/N ratio over a very wide range
- ◆ Wide noise bandwidth (16 MHz)

Applications

- ◆ Simulation of a noisy receive channel
- ◆ Noise simulation of a receiver input stage
- ◆ Sensitivity measurement of digital receivers to determine the BER at a defined C/N ratio

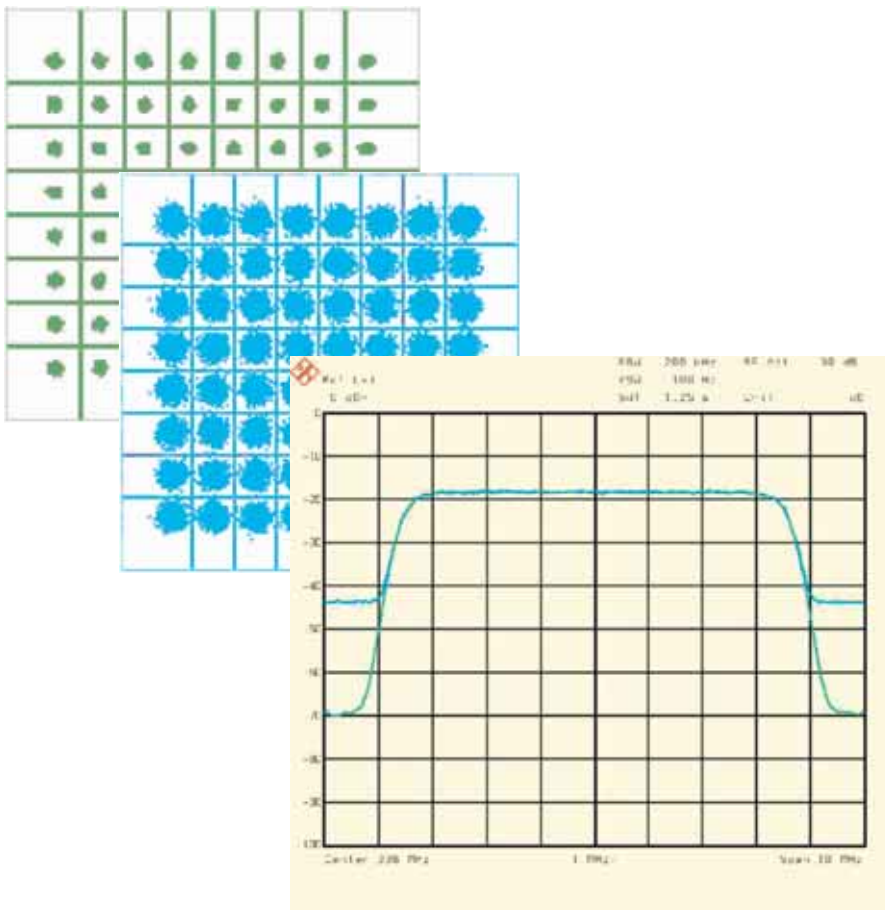

DVB-C spectrum without and with noise (24 dB C/N), associated I/Q constellations



Front and rear view of base unit and option R&S®SFL-N

BER measurement (option R&S®SFL-K17)

The BER measurement facility permits BER measurements on receivers without any external equipment. The demodulated data streams are re-applied to the R&S®SFL.

The user can choose between the serial inputs for DATA, CLOCK (BNC connectors, TTL level, high impedance) and the parallel input for MPEG-2 signals (D-Sub connector, LVDS level). The BER measurement function does not depend on other

settings; it can be used for all models of the R&S®SFL. The display of the current BER is always visible.

A PRBS of $2^{23}-1$ or $2^{15}-1$ in accordance with ITU-T Rec. O.151 can be selected and evaluated. It ensures receiver synchronization and allows measurements over a very wide BER range.

A serial BER measurement can be performed after the demapper, for example. For parallel measurements on MPEG-2 transmission systems, an MPEG-2 signal is required whose null packet features a

PRBS as the payload. For this purpose, the R&S®SFL offers NULL PRBS PACKET as an MPEG-2 transport stream. It also uses this packet for stuffing. The BER measurement can thus be carried out before the Reed-Solomon decoder, for example, provided that the receiver decoder has been switched off. The BER of set-top boxes can be determined by using an adapter board for the Common Interface R&S®SFQ-Z17.

Specifications

Specifications apply under the following conditions: 30 minutes warm-up time, specified environmental conditions met, calibration cycle adhered to and all internal adjustments performed.

Frequency	
Range	5 MHz to 1.1 GHz R&S®SFL-S: 5 MHz to 3.3 GHz
Resolution	0.1 Hz
Error limits	$<1 \times 10^{-6}$
Aging (after 30 days of operation)	$<1 \times 10^{-6}$ /year
Temperature effect (0°C to +55°C)	$<1 \times 10^{-6}$
Internal reference frequency output	10 MHz
Output voltage (V_{rms} , sinewave)	$>0.5 \text{ V}$ into 50Ω
Output impedance	50Ω
External reference frequency input	10 MHz
Permissible frequency drift	5×10^{-6}
Input voltage (V_{rms} , sinewave)	0.5 V to 2 V into 50Ω
Input impedance	50Ω
Spectral purity	
Spurious signals	
Harmonics	$<-30 \text{ dBc}$ for levels $\leq 0 \text{ dBm}$
Subharmonics	$<-50 \text{ dBc}$
Nonharmonics (offset from carrier $>10 \text{ kHz}$)	
$f \leq 250 \text{ MHz}$	$<-60 \text{ dBc}$
$f > 250 \text{ MHz}$ to 1.1 GHz	$<-70 \text{ dBc}$
$f > 1.1 \text{ GHz}$ to 2.2 GHz	$<-64 \text{ dBc}$
$f > 2.2 \text{ GHz}$ to 3.3 GHz	$<-58 \text{ dBc}$
SSB phase noise ($f=500 \text{ MHz}$, carrier offset 20 kHz , 1 Hz bandwidth)	$<-115 \text{ dBc}$
Spurious AM	$<0.05\%$ (0.03 kHz to 20 kHz)
Level	
Range	
CW	-140 dBm to $+7 \text{ dBm}$
R&S®SFL-C/R&S®SFL-T/R&S®SFL-I	-140 dBm to 0 dBm
R&S®SFL-S/R&S®SFL-V/R&S®SFL-J	-140 dBm to -3 dBm
Resolution	0.1 dB
Total error for level $>-127 \text{ dBm}$ (operating period $>1 \text{ h}$, temperature variation $<5^\circ\text{C}$)	$<\pm 0.8 \text{ dB}^{1)}$
Characteristic impedance	50Ω
VSWR	
$f < 1.5 \text{ GHz}$	<1.6
$f > 1.5 \text{ GHz}$	<2.3
Non-interrupting level setting ²⁾	0 dB to -20 dB of current level
Overtoltage protection	protects the instrument against externally fed RF power and DC voltage (50Ω source)
Maximum permissible RF power	
$f \leq 2.2 \text{ GHz}$	50 W
$f > 2.2 \text{ GHz}$	25 W
Maximum permissible DC voltage	35 V
I/Q modulator	
Modulation frequency response	
5 MHz to 1100 MHz	
DC to 3.5 MHz	$<\pm 0.2 \text{ dB}$
R&S®SFL-S: 425 MHz to 3000 MHz	
DC to 5 MHz	$<\pm 0.4 \text{ dB}$
DC to 25 MHz	$<\pm 0.8 \text{ dB}$
DC to 50 MHz	$<\pm 2 \text{ dB}$

Carrier leakage at 0 V input voltage, referred to nominal value	$<-50 \text{ dBc}$ (after I/Q calibration in CALIB menu)
Carrier suppression (residual carrier)	
Setting range	0% to +50%
Resolution	0.1%
I/Q amplitude (imbalance)	
Setting range	-25% to $+25\%$
Resolution	0.1%
Quadrature offset (phase error)	
Setting range	-10° to $+10^\circ$
Resolution	0.1°
External I/Q input	
Modulation inputs for I and Q signals	front panel
Input impedance	50Ω
VSWR (DC to 30 MHz)	<1.1
Input voltage for full-scale level	$(I^2 + Q^2)^{1/2} = 0.5 \text{ V}$ (1 V EMF, 50Ω)
Connectors	BNC female
Data input	
TS PARALLEL input	synchronous parallel, without stuffing (LVDS)
Characteristics	meet EN 50083-9
Input impedance	100Ω
Input level	100 mV to 2 V
Connector	25-pin female, shielded
SPI input	synchronous parallel, with stuffing (LVDS)
Characteristics	meet EN 50083-9
Input impedance	100Ω
Input level (V_{pp})	100 mV to 2 V
Connector	25-pin female, shielded
ASI input	asynchronous serial with stuffing
Characteristics	meet EN 50083-9
Input impedance	75Ω
Input level (V_{pp})	200 mV to 880 mV
Connector	BNC female
Input signal	270 Mbit
Stuffing bytes	single byte and block mode
SMPTE310 input	asynchronous serial (only with R&S®SFL-V)
Characteristics	meet SMPTE310M
Input impedance	75Ω
Input level (V_{pp})	400 mV to 880 mV
Connector	BNC female
Data rate	19.393 Mbit/s
Symbol rate	
TS PARALLEL, SMPTE310	directly dependent on applied MPEG-2 signal
ASI, SPI	selectable independently of MPEG-2 signal (stuffing)
Internal data clock accuracy	$<\pm 1 \times 10^{-5}$
External clock	switchable to external bit/byte synchronization
Signal	squarewave
Level	TTL
Input impedance	high
Connector	BNC female

¹⁾ ALC Off mode = sample&hold.

²⁾ Effect on spectral purity.

R&S®SFL-T

DVB-T/H coder	
Characteristics	meet EN300744/EN 302304
Mode	MPEG-2 input signal synchronized to input data rate
DATA	MPEG-2 input signal synchronized to input data rate
NULL TS PACKET	null transport stream packets as defined by DVB Measurement Guidelines
NULL PRBS PACKET	null transport stream packets with PRBS (PRBS: $2^{23}-1/2^{15}-1$ to ITU-T Rec. 0.151)
PRBS before convolutional encoder	$2^{23}-1/2^{15}-1$ to ITU-T Rec. 0.151
PRBS after convolutional encoder	$2^{23}-1/2^{15}-1$ to ITU-T Rec. 0.151
PRBS before mapper	$2^{23}-1/2^{15}-1$ to ITU-T Rec. 0.151
Hierarchical coding	
MPEG-2 transport stream	external MPEG-2 transport stream and internal NULL PRBS PACKET
Priority assignment	selectable
Special functions	scrambler, sync byte inversion, Reed-Solomon encoder, convolutional interleaver, bit interleaver, symbol interleaver; can be disabled
Symbol interleaver	native/indepth
Time slicing	on/off
MPE-FEC	on/off
Bandwidth	5 MHz, 6 MHz, 7 MHz, 8 MHz; selectable for variable bandwidth 4.75 MHz to 7.962 MHz
Constellation	QPSK, 16QAM, 64QAM
Code rate	1/2, 2/3, 3/4, 5/6, 7/8
Guard interval	1/4, 1/8, 1/16, 1/32, OFF
FFT mode	2k, 4k and 8k OFDM
Carrier modification	carriers or groups of carriers can be switched off; modulation for groups of carriers can be switched off
Modulation frequency response	± 0.2 dB
Shoulder attenuation	48 dB

R&S®SFL-V

ATSC/8VSB coder	
Characteristics	meet ATSC Doc. A/53 (8VSB)
Mode	MPEG-2 input signal with synchronization to input data rate
DATA	MPEG-2 input signal with synchronization to input data rate
NULL TS PACKET	null transport stream packets as defined by DVB Measurement Guidelines
NULL PRBS PACKET	null transport stream packets with PRBS (PRBS: $2^{23}-1/2^{15}-1$ to ITU-T Rec. 0.151)
SYNC PRBS	sync byte with 187 byte PRBS payload
PRBS before trellis	$2^{23}-1/2^{15}-1$ to ITU-T Rec. 0.151
PRBS after trellis	$2^{23}-1/2^{15}-1$ to ITU-T Rec. 0.151
Symbol rate	10.762 Msps
Range	$\pm 10\%$
Bandwidth	6 MHz
Range	$\pm 10\%$
Pilot addition	can be switched off
Nominal	1.25 for 8VSB
Range	0 to 5, in steps of 0.125 for 8VSB
Pulse filtering (root cosine)	0.115 roll-off
Special functions	Reed-Solomon, randomizer, interleaver; can be disabled

Modulation frequency response	± 0.25 dB
Shoulder attenuation	53 dB
MER	41 dB

R&S®SFL-I

ISDB-T coder	
Characteristics	meet ARIB STD-B31, V1.0
Mode	
DATA	PRBS: $2^{23}-1/2^{15}-1$ to ITU-T Rec. 0.151
NULL TS PACKET	PRBS: $2^{23}-1/2^{15}-1$ to ITU-T Rec. 0.151
PRBS TS PACKET	PRBS: $2^{23}-1/2^{15}-1$ to ITU-T Rec. 0.151
PRBS before convolutional encoder	PRBS: $2^{23}-1/2^{15}-1$ to ITU-T Rec. 0.151
PRBS after convolutional encoder	PRBS: $2^{23}-1/2^{15}-1$ to ITU-T Rec. 0.151
Special functions	scrambler, Reed-Solomon, byte interleaver, frequency interleaver, Alert Broadcasting Flag can be switched off
Bandwidth	6 MHz
Carriers	data, SP, CP, TMCC and AC carriers as well as modulation of these carriers can be switched off
Segments	all carriers of one segment can be switched off
ISDB-T mode	mode 1 (2k), mode 2 (4k), mode 3 (8k)
Number of layers	max. 3 (A, B, C)
Number of segments	13
Constellation	DQPSK, QPSK, 16QAM, 64QAM
Code rate	1/2, 2/3, 3/4, 5/6, 7/8
Guard interval	1/4, 1/8, 1/16, 1/32, OFF
Time interleaving	0, 1, 2, 4, 8, 16 (settable depth depending on ISDB-T mode)
AC information	PRBS, all "1"
Spectrum mask	meets ISDB-T specifications

R&S®SFL-C

DVB-C coder	
Characteristics	meet EN300429, ITU-T J.83/A, C
Type of modulation	16QAM, 32QAM, 64QAM, 128QAM, 256QAM
Symbol rates	0.1 Msps to 8 Msps (selectable)
Pulse filtering	root cosine roll-off, $\alpha=0.15$ variable roll-off (0.1 to 0.2)
Energy dispersal	can be disabled
Reed-Solomon coder (204,188, $t=8$)	can be disabled
Convolutional interleaver	can be disabled
Mode	
DATA	MPEG-2 input signal (without input signal automatic switchover to PRBS with TS PARALLEL, stuffing with ASI, SPI)
NULL TS PACKET	null packets (PID=1FFF, payload=0)
NULL PRBS PACKET	null packets (PID=1FFF, payload=PRBS, $2^{15}-1/2^{23}-1$ to ITU-T Rec. 0.151)
PRBS before mapper	$2^{15}-1/2^{23}-1$ to ITU-T Rec. 0.151
Modulation frequency response	± 0.25 dB
Shoulder attenuation (6.9 Msps)	48 dB
MER	41 dB

R&S®SFL-J

J.83/B coder	
Characteristics	meet ITU-T J.83/B
Mode	
DATA	MPEG-2 input signal with synchronization to input data rate
NULL TS PACKET	null transport stream packets as defined by DVB Measurement Guidelines
NULL PRBS PACKET	null transport stream packets with PRBS (PRBS: $2^{23}-1/2^{15}-1$ to ITU-T Rec. 0.151)
SYNC PRBS	sync byte with 187 byte PRBS payload (PRBS: $2^{23}-1/2^{15}-1$ to ITU-T Rec. 0.151)
PRBS before trellis	$2^{23}-1/2^{15}-1$ to ITU-T Rec. 0.151
PRBS after trellis	$2^{23}-1/2^{15}-1$ to ITU-T Rec. 0.151
Symbol rate	5.0569 Msps (64 QAM), 5.360 Msps (256 QAM)
Range	±10%
Bandwidth	6 MHz
Range	±10%
Pulse filtering (root cosine)	0.18 (64 QAM), 0.12 (256 QAM)
Data interleaver	level 1 and level 2; can be disabled
Special functions	Reed-Solomon, randomizer, interleaver; can be disabled
Modulation frequency response	±0.25 dB
Shoulder attenuation	53 dB
MER	42 dB

R&S®SFL-S

DVB-S/-DSNG coder	
Characteristics	meet EN300421/EN301210
Type of modulation	QPSK, 8PSK, 16QAM
Code rate	QPSK: 1/2, 2/3, 3/4, 5/6, 7/8 8PSK: 2/3, 5/6, 8/9 16QAM: 3/4, 7/8
Symbol rates	0.1 Msps to 80 Msps (selectable)
Pulse filtering	root cosine roll-off, $\alpha=0.35$ variable roll-off (0.25 to 0.45)
Energy dispersal	can be disabled
Reed-Solomon coder (204, 188, t=8)	can be disabled
Convolutional interleaver	can be disabled
Convolutional encoder	can be disabled
Mode	
DATA	MPEG-2 input signal (without input signal automatic switchover to PRBS with TS PARALLEL, stuffing with ASI, SPI)
NULL TS PACKET	null packets (PID=1FFF, payload=0)
NULL PRBS PACKET	null packets (PID=1FFF, payload=PRBS, $2^{15}-1/2^{23}-1$ to ITU-T Rec. 0.151)
PRBS before convolutional encoder	$2^{15}-1/2^{23}-1$ to ITU-T Rec. 0.151
Modulation frequency response	±0.25 dB
Shoulder attenuation	48 dB

Options

Noise generator

Option R&S®SFL-N	
Noise characteristics	
Bandwidth	
Selectable receiver bandwidth	0.1 MHz to 10 MHz max. 10 Msps for satellite
RF noise bandwidth (−1 dB)	16 MHz
C/N settings	
Variation range	60 dB
Minimum selectable C/N	0 dB (carrier bandwidth ≥6 MHz)
Resolution	0.1 dB
C/N error	
Absolute error	<0.3 dB (after calibration), typ. 0.2 dB
RF characteristics	
Additional frequency response (max. 5 MHz carrier offset)	<0.4 dB
Limitation of maximum RF output level	>0 dB to 18 dB (in steps of 6 dB)
Residual carrier	typ. −50 dBc
Minimum RF frequency with Noise On	>15 MHz

BER measurement

Option R&S®SFL-K17	
Input data rate	max. 63 Mbit/s serial, 80 Mbit/s parallel
PRBS sequences	$2^{15}-1/2^{23}-1$ to ITU-T Rec. 0.151
Input	
Serial	BER DATA/BER CLOCK
Input impedance	high impedance
Input level	TTL
Connector	BNC connector
Clock, data	normal, inverted
BER Mode	$2^{15}-1/2^{23}-1$ to ITU-T Rec. 0.151
PRBS	
Parallel	TS PARALLEL
Characteristics	meet EN50083-9
Input impedance	100 Ω
Input level	100 mV to 2 V, LVDS
Connector	25-pin female, shielded
BER mode	MPEG-2 transport stream payload
PRBS, PRBS INVERTED	payload evaluation as PRBS ¹⁾
NULL PRBS PACKET	payload evaluation with PID 1FFFhex
PID FILTER FOR PRBS PACKET	as PRBS ²⁾

- 1) Standard transport stream evaluation. The four header bytes are removed and the 184 bytes of payload evaluated as PRBS. This corresponds to the NULL PRBS PACKET mode in the R&S®SFL.
- 2) Standard transport stream evaluation. The PID filter selects null packets with PID = 1FFFhex. Only the payload of these packets is evaluated as PRBS. This corresponds to the ASI or SPI mode in the R&S®SFL, where NULL PRBS PACKETS are used for stuffing.

General data

Memory for instrument settings	50
Remote control	IEC 60625 (IEEE 488) RS-232-C
Command set	SCPI 1995.0
Operating temperature range	+5 °C to +45 °C
Permissible temperature range	0 °C to +50 °C
Storage temperature range	-40 °C to +70 °C
Mechanical resistance	
Vibration, sinusoidal	5 Hz to 150 Hz, max. 2 g at 55 Hz, 55 Hz to 150 Hz, 0.5 g const., meets IEC 60068-2-6, IEC 61010
Vibration, random	10 Hz to 300 Hz, acceleration 1.2 g (rms)
Shock	40 g shock spectrum, meets MIL-STD-810D
Climatic resistance	
Damp heat	95% rel. humidity, cyclic test at +25 °C/+40 °C, meets IEC 60068
Electromagnetic compatibility	EMC Directive of EU

Immunity to RFI	10 V/m
Electrical safety	EN 61010-1, IEC 61010, UL3111-1, CSA-C22.2 No.1010.1

Base unit

Power supply	100 V to 120 V (AC), 50 Hz to 60 Hz 200 V to 240 V (AC), 50 Hz to 60 Hz max. 250 VA
Dimensions (W × H × D)	427 mm × 88 mm × 450 mm (2 HU)
Weight	11 kg

Option R&S®SFL-N

Power supply	100 V to 240 V (AC), 50 Hz to 60 Hz max. 60 VA
Dimensions (W × H × D)	Option R&S®SFL-N 427 mm × 55 mm × 450 mm (1 HU) Base unit with option R&S®SFL-N 427 mm × 154 mm × 450 mm (3 HU)
Weight	Option R&S®SFL-N 5 kg Base unit with option R&S®SFL-N 16 kg

Ordering information

Order Designation	Type	Order No.
TV Test Transmitter DVB-T/H	R&S®SFL-T	2084.4005.20
TV Test Transmitter ATSC/8VSB	R&S®SFL-V	2084.4005.30
TV Test Transmitter ISDB-T	R&S®SFL-I	2084.4005.50
TV Test Transmitter DVB-C	R&S®SFL-C	2084.4005.15
TV Test Transmitter J.83/B	R&S®SFL-J	2084.4005.40
TV Test Transmitter DVB-S/DVB-DSNG	R&S®SFL-S	2084.4005.10
Option		
Noise Generator	R&S®SFL-N	2084.4040.02
BER Measurement	R&S®SFL-K17	2084.5682.02
Recommended extras		
Service Kit		2084.4340.02
Service Manual		2084.4128.22
19" Adapter for rackmounting (base unit)	R&S®ZZA-211	1096.3260.00
19" Adapter for rackmounting (R&S®SFL-N)	R&S®ZZA-111	1096.3254.00
Matching Pads 50 Ω/75 Ω		
Matched at both ends, attenuation 5.7 dB, no DC isolation	R&S®RAM	0358.5414.02
Matched at one end, attenuation 1.7 dB	R&S®RAZ	0358.5714.02
Bag (2 HU)	R&S®ZZT-214	1109.5119.00



More information at
www.rohde-schwarz.com
(search term: SFL)



ROHDE & SCHWARZ

www.rohde-schwarz.com

Europe: Tel. +49 1805 12 4242, e-mail: customersupport@rohde-schwarz.com

North America: Tel. 888 837 87 72, option 2 (from within the USA and Canada), +1410-910-7800, option 2 (from other countries), e-mail: customer.support@rsa.rohde-schwarz.com

Asia: Tel. +65 68463710, e-mail: customersupport.asia@rohde-schwarz.com