

Vector Signal Analyzer FSE-B7 for Spectrum Analyzers FSE

Universal demodulation, analysis and documentation of digital and analog mobile radio signals

For all major mobile radio communication standards:

- GSM/DCS1800/PCS1900
- NADC
- TETRA
- PDC
- PHS
- DECT
- QCDMA (IS95)

For all common digital and analog modulation modes:

- BPSK
- QPSK, OQPSK
- $\pi/4$ DQPSK
- 8PSK, 8DPSK
- (G)MSK
- (G)FSK
- 4FSK
- 16QAM
- AM/FM/ ϕ M

Optimum representation of results:

- In-phase and quadrature signals
- Magnitude, phase
- Eye and trellis diagrams
- Vector diagram
- Constellation diagram
- Table with modulation errors
- Demodulated bit stream



ROHDE & SCHWARZ

Characteristics

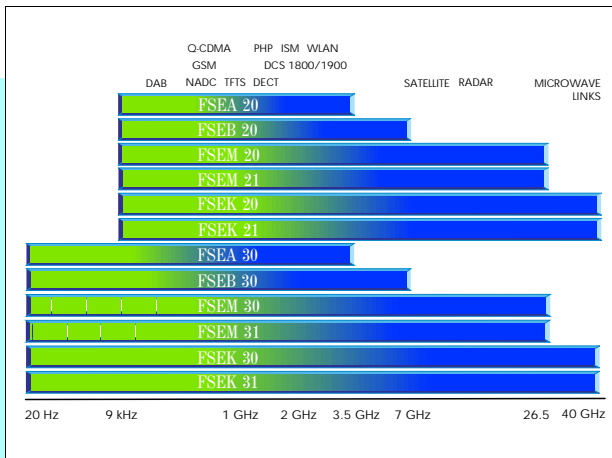

The vector signal analyzer option can be used with all analyzers of the FSE family to cover the frequency range up to 40 GHz for future-oriented applications

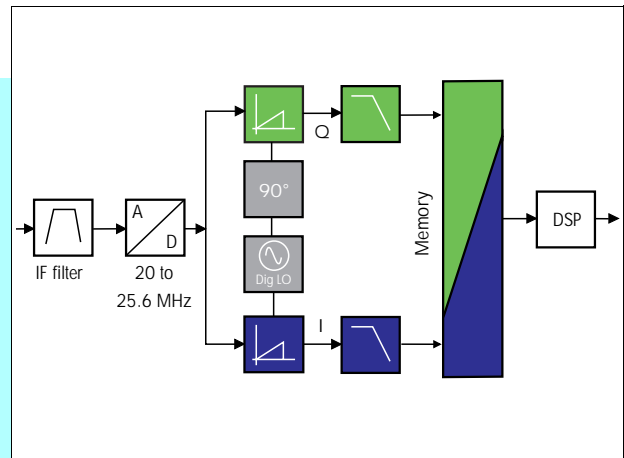

Operating principle of Vector Signal Analyzer Option FSE-B7

Universal analysis of digital mobile radio signals

The vector signal analyzer option upgrades the high-quality Spectrum Analyzers FSE, adding universal demodulation and analysis capability down to bit stream level for digital mobile radio signals. The option supports all common mobile radio communication standards.

Measurement and analysis of analog modulation signals

You want to measure and analyze analog amplitude-, frequency- or phase-modulated signals? This can easily be done even up to 40 GHz with the vector signal analyzer option in Microwave Spectrum Analyzer FSEK.

In addition to standard measurements such as determination of frequency

deviation or modulation depth, this option also allows measurements of frequency transients or spurious FM on synthesizers or transmitters.

Since option FSE-B7 can analyze analog and digital modulation signals, it is an ideal tool for use in development and production of dual-mode mobile telephones, for example.

Versatile in the lab

You may want to develop future or company standards, use unconventional formats or modify synchronization sequences. In all these cases, FSE with option FSE-B7 will support you by providing user-selectable bit and symbol rates, filters, modulation modes and synchronization sequences.

Efficient in production

The high measurement speed of 25 sweeps/s in the analyzer mode and typically 3 measurements/s using the vector signal analyzer function is ideal for applications in production. The high flexibility allows multistandard test systems to be configured for easy adaptation to varying production requirements.

Any mobile radio standard at a single keypress

The high flexibility offered by the analyzers is by no means at the price of complicated operations: all major digital modulation standards can be activated at a single keypress. The instrument is then completely configured for measurements in line with the activated

Applications

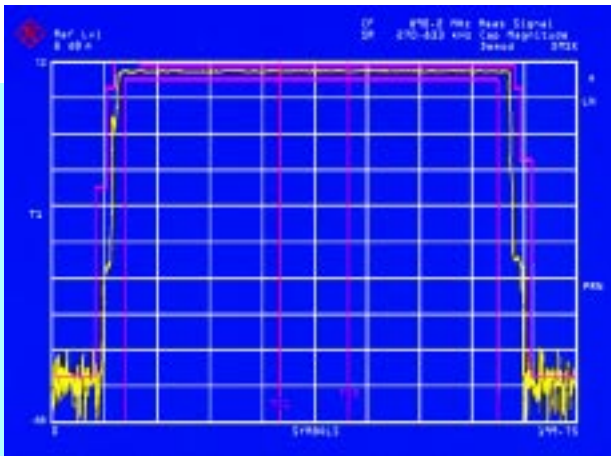

1

- 1 Measurement of GSM power ramps to standard with high-precision time reference through synchronization to midamble
- 2 I/Q signal and phase error measurement over 50 symbols of a GSM mobile
- 3 Phase error, demodulated bits and numeric readout for modulation errors

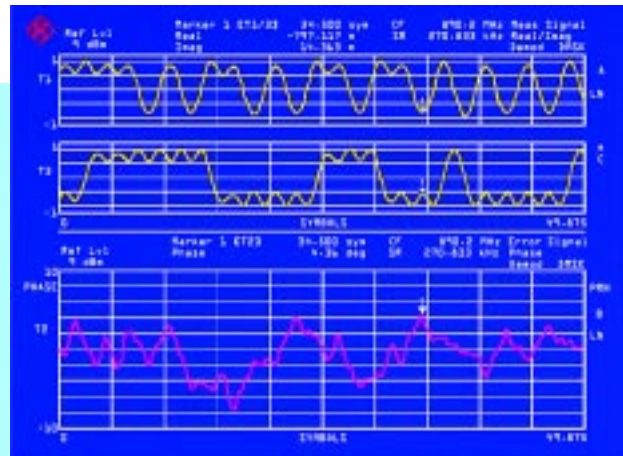

2

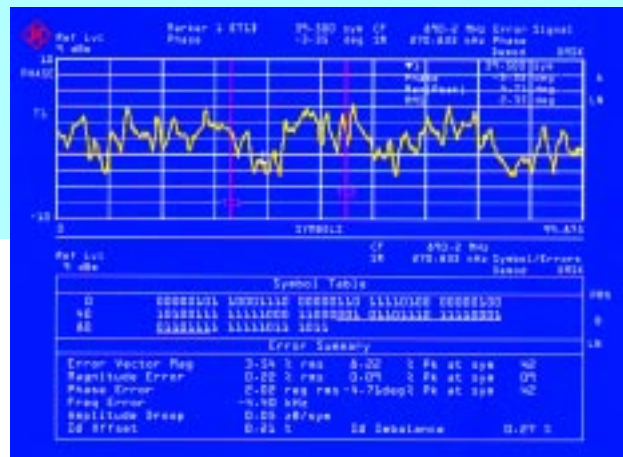

3

standard. The corresponding synchronization sequences are of course offered along with the standard.

Multiple test functions integrated in one unit

Analyzers FSE in conjunction with option FSE-B7 replace several individual instruments:

- High-grade spectrum analyzer
- Vector demodulator
- Constellation analyzer or
- Process controller

Principle of vector signal analysis

The IF signal is digitized by means of a fast A/D converter, allowing purely digital processing of all subsequent analysis steps, thus making them practically error-free and providing high long-term and temperature stability. After A/D conversion, the signal is dig-

itally mixed into the baseband and split into a real and an imaginary component. The complete signal information is thus available for further analysis. The signal is demodulated down to bit level by several DSPs. From the data stream thus obtained, an ideal signal is calculated. This reference signal is compared with the test signal. The resulting difference signal contains all modulation errors. The sampling rate of the A/D converter is always set to an integer multiple of the symbol rate, which speeds up analysis and contributes to the high rate of 3 measurements/s.

Applications

Power ramp measurements in line with standards (1)

To perform these measurements on TDMA systems such as GSM in line with standards, a time reference must be established from synchronization sequences to pre- or midamble. This is done in the SYNC-SEARCH mode, in which the analyzer triggers on preset or user-defined bit sequences. This not only allows established standards to be measured with high precision, but also modified settings in the case of new developments. Further trigger modes are:

- Video
- External
- Burst search

Applications

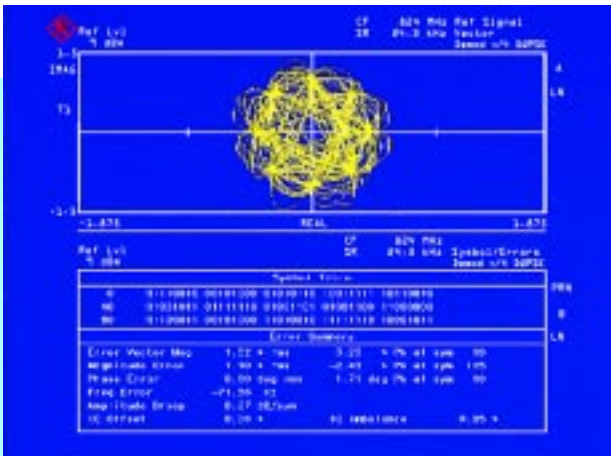

4

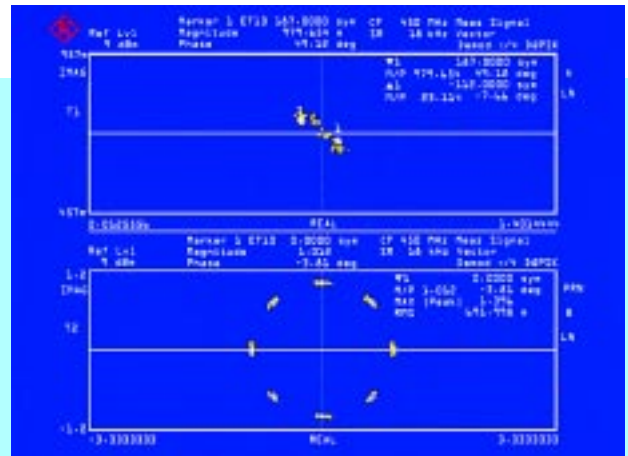

5

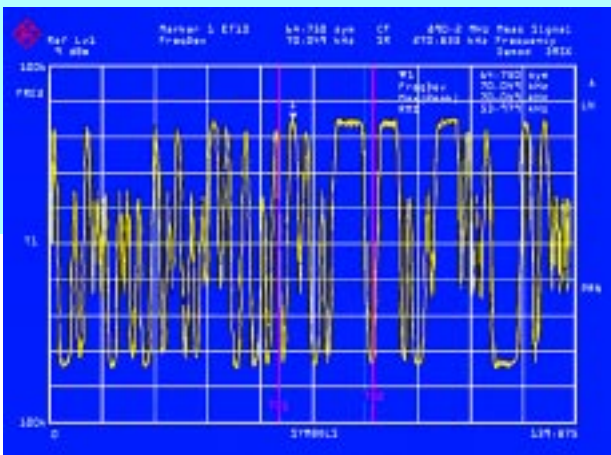

6

- 4 Measurement of modulation errors of $\pi/4$ DQPSK signals (NADC)
- 5 Constellation diagram of TETRA signal with phase noise. Bottom: complete diagram, top: detail zoomed by factor of 5
- 6 Frequency response of GSM signal and automatic deviation measurement with modulation marker

Phase error measurements on GSM mobiles or base stations (2 and 3) The low inherent phase error of $<0.5^\circ$ (rms) of option FSE-B7 substantially reduces uncertainty. Tolerances, eg an rms phase error of 5° for GSM, can thus be allowed practically completely for the DUT, thus widening the DUT tolerance margin. The SYMBOL TABLE / ERROR SUMMARY lists the demodulated bits and the errors found. The bit sequences and the errors can be read via the fast IEC/IEEE bus of the analyzer. The deviation can be rapidly determined from the frequency display by means of modulation markers.

Modulation error measurements on $\pi/4$ DQPSK signals (4) The upper screen (A) shows the vector diagram of an NADC signal, the lower screen gives a summary of relevant errors, measured over a burst signal.

Convenient analysis with constellation diagram (5) The constellation diagram enables convenient analysis of the degradation of modulation accuracy caused, for example, by nonlinearities, phase noise or amplitude-dependent phase response of amplifiers, converters, etc. The lower screen (B) shows the complete constellation diagram, the upper screen (A) a zoomed detail that allows accurate examination of the error distribution.

Frequency deviation of GSM signal (6) The frequency deviation versus time characteristic – shown here as deviation versus symbols – is rms-weighted by means of the modulation marker. It is also possible to measure the rms deviation for any part of the burst, eg for the midamble.

Measurements on frequency-modulated signals (7) In addition to the frequency deviation measurement on the demodulated signal (screen A) with markers, eg the $\pm pk/2$ marker, MODULATION SUMMARY (screen B) offers a complete overview of the signal parameters:

- Frequency deviation, peak and rms
- Carrier frequency offset from the set receive frequency
- Carrier level
- AM component with FM or

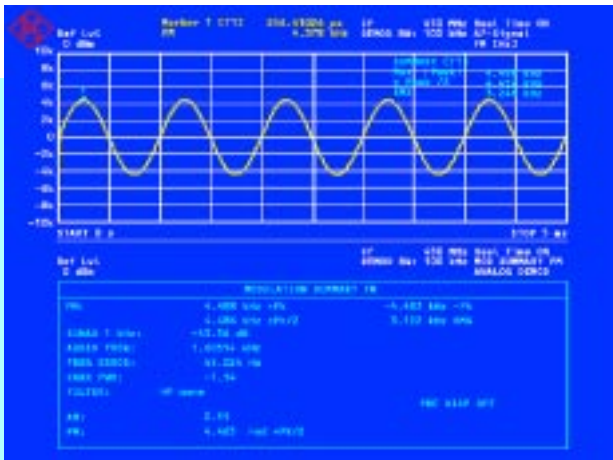

7

- 7 Modulation measurement on frequency-modulated signals with simultaneous analysis of all relevant parameters
- 8 Measurement of synchronous frequency/phase modulation or AM/φM conversion with simultaneous representation of AM and FM component
- 9 Measurement of transmitter frequency transients with -30 dB FM squelch

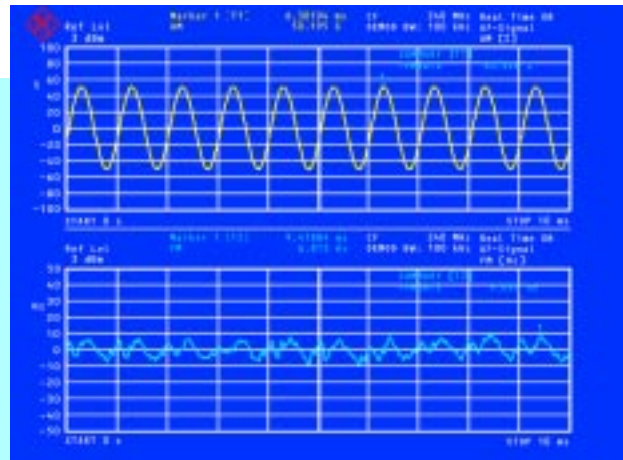

8

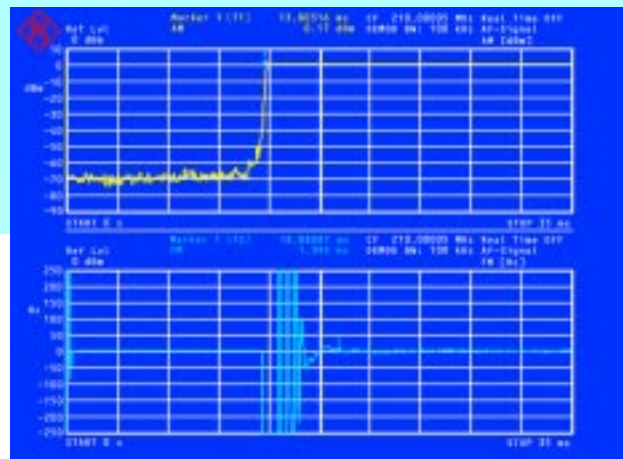

9

- SINAD value for a modulation frequency of 1 kHz

The following filters can be switched in for weighted measurements:

- Highpass filters 30 Hz, 300 Hz
- Lowpass filters 3 kHz, 15 kHz
- Weighting filters to CCITT and C-message filter

Measurement of AM/φM conversion or synchronous phase modulation (8)

The amplifiers and/or modulators (components) of many transmission systems are operated close to saturation to obtain better efficiency. The resulting AM/φM conversion causes errors in particular with digital phase-modulated systems and cross-talk with analog multicarrier systems.

The low inherent synchronous modulation component and the capability of combining FSE-B7 with microwave analyzers (eg FSEK up to 40 GHz) allows the measurement of AM/φM conversion up to the highest frequencies. FSE simultaneously displays the AM component (screen A) and the resulting FM or φM component (screen B). An AM signal with very low synchronous FM/φM can be generated by I/Q modulation of Tracking Generators FSE-B9/-B11.

Measurement of transmitter frequency transients (9)

The measurement of frequency transients is supported by various functions:

- DC-coupled demodulators enabling the power ramp to be accurately

determined with the AM demodulator

- Split screen for simultaneous display of level transients (screen A) and frequency transients (screen B)
- High resolution of eg 100 Hz/div. selectable for the frequency axis
- Settable squelch which in the example shown switches on the FM demodulator at -30 dBm, thus suppressing the noise produced if there is no signal level
- Settable video trigger, trigger delay and pretrigger

Specifications

Specifications are guaranteed subject to the following conditions:

5 minutes warmup at ambient temperature, specified environmental conditions met, calibration cycle adhered to and total calibration performed. Data without tolerances are typical values. Data designated "nominal" apply to design parameters and have not been checked.

Measurement of digital modulation signals

Signal types	continuous signals, TDMA signals
Modulation modes	BPSK, QPSK, Offset QPSK, DQPSK, $\pi/4$ DQPSK, 8PSK, D8PSK, 16QAM, MSK/GMSK, 2(G)FSK, 4(G)FSK
Standards	GSM/DCS1800/PCS1900, NADC, TETRA, PDC, PHS, CDPD, DECT, PWVT/WCPE, CT2, ERMES, FLEX, MODACOM, TETS, QCDMA (IS95), APCO 25 FM
Filters	
Filter types	raised cosine, square root raised cosine, Gaussian
Setting range $\alpha/B \times T$	0.2 to 3 in steps of 0.01
Filters to specific standards	
FLEX	Bessel $B \times T = 1.22$ and 2.44
ERMES	Bessel $B \times T = 1.25$
QCDMA	forward and reverse channel (IS95)
APCO 25 FM	
Measurements (except FSK)	I and Q signals (filtered, synchronized to frequency and symbol clock) I and Q reference signals (calculated from demodulated bits) I and Q error (magnitude and phase) error vector bit stream/modulation error (symbols demodulated at ideal decision points and table of all modulation errors)
Measurements with FSK	frequency-demodulated signal (filtered, synchronized to symbol clock) FSK reference signal (calculated from demodulated data) FSK error signal data/bit stream/modulation error (symbols demodulated at ideal decision points and table of all modulation errors)
Display modes (except FSK)	
Polar diagram	constellation diagram vector diagram
Time domain	in-phase and/or quadrature signal magnitude (level) phase eye diagram trellis diagram
Error display in time domain	error vector magnitude (EVM) in % magnitude error phase/frequency error in-phase and quadrature signals error vector magnitude* magnitude error*, phase error* frequency error I/Q offset I/Q imbalance amplitude droop ρ factor
Numerical error readout (* rms and peak value)	

Display modes with FSK	
Time domain	magnitude (level) frequency deviation eye diagram (frequency signal)
Error display in time domain	frequency deviation error magnitude error deviation error* magnitude error FSK frequency deviation frequency error FSK reference deviation
Numerical error readout (* rms and peak value)	
Modulation measurement range	
Symbol rate	320 Hz to 2 MHz
Testpoints/symbol ¹⁾	
Symbol rate ≤ 200 kHz	1, 2, 4, 8, 16
200 kHz < symbol rate ≤ 400 kHz	1, 2, 4, 8
Symbol rate > 400 kHz	1, 2, 4
Memory size	
Symbol rate ≤ 1 MHz	max. 16 000 points
Symbol rate > 1 MHz	max. 3200 points
Number of demodulated symbols	
Symbol rate ≤ 1 MHz	max. 1600 symbols (with 4 points/symbol), max. 800 symbols (with 8 points/symbol), max. 400 symbols (with 16 points/symbol)
Symbol rate > 1 MHz	max. 600 symbols
Synchronization	
Symbol clock	internal
Frequency/phase	internal
Trigger	free run, external, video
Trigger offset	pre- or posttrigger
Synchronization on bit sequences	definable bit sequences, max. 32 symbols, TDMA bursts
Synchronization offset	selectable, positive or negative
Level measurements	
Peak power range	-60 to +30 dBm
Dynamic range for burst measurement (mean power, ref. level ≥ -10 dBm, peak power = ref. level + 1 dB, low-noise mode, points/symbol ≤ 4)	80 dBc - 4 \times log(symbol rate/kHz)
Absolute level error	
Mean power (0 to -10 dB below reference level)	
$f \leq 1$ GHz	1 dB
$f > 1$ GHz	see FSE data sheet (total measurement uncertainty)
Relative level error	
Mean power, level	
0 to -10 dB below reference level	0.2 dB
-10 to -50 dB below reference level	(0.0325/dB - 0.125) dB
Time reference (nominal)	
without clock synchronization	$< 1/(2 \times \text{symbol rate} \times \text{points/symbol})$ for MSK/GMSK modulation, $< 1/(2 \times \text{symbol rate})$ for PSK/QAM/FSK modulation
with clock synchronization	$< 0.001 \times 1/(\text{symbol rate})$

¹⁾ 4 points/symbol is the lowest value. With settings of 1 or 2 points/symbol, only 1 or 2 points of the 4 points/symbol are displayed.

Residual error in modulation measurements

(level in range ref. level to ref. level -6 dB; S/N >60 dB, $\alpha/B \times T = 0.3$ to 0.7, number of demodulated symbols >100, averaging ≥ 10 , analog bandwidth >10 x symbol rate)

Input frequency models 20 ≥ 20 MHz
models 30 >15 x symbol rate, local suppression calibrated

General modulation modes (except FSK)²⁾

	Symbol rate		
	<30 kHz	30 kHz to <300 kHz	300 kHz to <2 MHz
Error vector magnitude (EVM)	0.5% rms	1% rms	2% rms
Magnitude error	0.5% rms	1% rms	2% rms
Phase error (modulation modes with constant amplitude)	0.3° rms	0.5° rms	1.5° rms
Frequency error	$\pm(\text{symbol rate} \times 5 \times 10^{-6} + 0.1 \text{ Hz} + \text{reference error} \times \text{carrier frequency})$; for reference error, see data sheet Spectrum Analyzers FSE		
I/Q offset error	0.2% (-54 dB)		

Modulation standards

Standard	Error vector magnitude	Phase error	RHO factor
GSM (DCS1800/PCS1900)	-	$\leq 0.5^\circ$ rms, typ. <1.5° peak	-
NADC, CDPD	$\leq 0.5\%$ rms, typ. <1.5% peak	-	-
TETRA, PDC	$\leq 0.7\%$ rms, typ. <2% peak	-	-
PHS	$\leq 0.7\%$ rms, typ. <2% peak	-	-
PWT	$\leq 1\%$ rms, typ. <3% peak	-	-
QC/QM, forward/reverse channel	-	-	≥ 0.9995

General FSK modulation modes²⁾

	Symbol rate	
	<300 kHz	300 kHz to 2 MHz
(input level ≥ -10 dBm, low-noise mode)	1.5% rms	2% rms
Deviation error ³⁾	1.5% of ref. deviation	2% of ref. deviation
FSK deviation	1% rms	2% rms
Magnitude error	0.5% of ref. deviation + error of ref. frequency	0.5% of ref. deviation + error of ref. frequency
Frequency offset		

Standards

Input level ≥ -10 dBm, low-noise mode, all standards, except ERMES; FLEX: 4 points/symbol, ERMES and FLEX: 16 points/symbol
DECT $\leq 2\%$ rms, typ. <6% peak
MODACOM, CT2 $\leq 1.5\%$ rms, typ. <3% peak
ERMES, FLEX $\leq 2\%$ rms, typ. <6% peak

Measurement times

Readout of detected symbols and numerical modulation errors, synchronized:

GSM, DCS1800, PCS1900 330 ms

²⁾ Data are valid for FSEA30 or FSEA20 with option FSE-B4 for frequencies <1 GHz in the low-noise mode (ATTEN AUTO LOW NOISE), level ≥ -10 dBm.

For frequencies ≥ 1 GHz the specified values must be multiplied by $10^{0.552 \times \log f[\text{GHz}]/1[\text{GHz}]}$.

The following applies to FSEB30/FSEM30 or FSEB20/FSEM20 with option FSE-B4:

For frequencies <1 GHz the specified data must be multiplied by 1.4; for frequencies ≥ 1 GHz the specified data must be multiplied by 1.4 and additionally by $10^{0.354 \times \log f[\text{GHz}]/1[\text{GHz}]}$; data for FSEA20, FSEB20, FSEM20 without option FSE-B4 are typically degraded by a factor of 3 as compared to FSEA30, FSEB30, FSEM 30 or FSEA20, FSEB20, FSEM20 with option FSE-B4.

³⁾ $+2 \times 10^{-4} \times f_{\text{symbol}} \times (\text{points/symbol})$ [Hz].

NADC, TETRA, TETS, PWT/WCPE, PDC, CDPD, DECT, ERMES, FLEX, MODACOM 800 ms

Measurement of analog modulation signals

(Data valid for firmware version 1.62 and higher)

Demodulation bandwidth

Realtime demodulation 5 to 200 kHz in steps of 1,2,3,5
Offline demodulation 5 kHz to 5 MHz in steps of 1,2,3,5

Demodulation length

(max. sweep time) 3500/(demod. bandwidth/Hz) s

Readout Trace with AF signal, carrier power (AM DC-coupled), or modulation summary (table) with numerical display of:
- peak and rms values of modulation depths or deviations of main demodulation
- SINAD value 1kHz (only with realtime demodulation)
- AF frequency
- carrier power
- peak values of secondary modulations

The following specifications are valid for demodulation bandwidth ≤ 2 MHz, IF bandwidth ≥ 5 x demodulation bandwidth, RF input level ≤ -10 dBm, reference level setting = peak input level + 0 to +6 dB.

Amplitude demodulation

Range up to 100%

AF

Offline demodulation 0.001 to 0.2 x demod. BW
Realtime demodulation 30 Hz to 0.2 x demod. BW, max. 20 kHz

Error

Distortion (realtime demod.) $\leq 5\%$ of result + residual AM

RF freq. <26.5 GHz
SINAD 1kHz with m = 80%, LP 3 kHz

Residual AM

RF freq. <26.5 GHz, demod. BW ≤ 100 kHz, rms demod. BW >100 kHz, rms 0.2%
0.2% x $\sqrt{\text{Demod. BW}/100 \text{ kHz}}$

Incidental AM with FM

$\Delta f = 0.2 \times \text{demod. BW}$,
 $f_{\text{mod}} = 1$ kHz,
10 kHz \leq demod. BW ≤ 200 kHz, lowpass 5% of demod. BW or 3 kHz, center frequency tuning $\leq 2\%$ + residual AM

Frequency demodulation

Deviation range max. 0.4 x demod. BW

AF

Offline demodulation DC/0.001 to 0.2 x demod. BW
Realtime demodulation DC/30 Hz to 0.2 x demod. BW, max. 20 kHz

Error (AF up to 0.1 x demod. BW) $\leq 5\%$ of result + residual FM

Distortion⁴⁾ (realtime demodulation)

RF ≤ 1 GHz, demod. BW ≥ 10 kHz, SINAD 1 kHz with $\Delta f = 0.2 \times \text{demod. BW}$, LP 3 kHz >50 dB

Residual FM⁵⁾

demod. BW ≤ 200 kHz, lowpass 5% of demod. BW

⁴⁾ Models FSEA20, FSEB20, FSEM20, FSEK20 without option FSE-B4: SINAD specification with FM is valid for deviations ≥ 10 kHz, with ϕM at deviation = 10 rad due to increased residual FM/ ϕM . The stated values are typical. Incidental FM/ ϕM with AM is not specified due to increased residual FM/ ϕM .

⁵⁾ Data are valid for FSEA30 or FSEA20 with option FSE-B4 for RF ≤ 1 GHz. FSEB30, FSEM30, FSEK30 or FSEB20, FSEM20, FSEK20 with option FSE-B4: Residual modulation is higher by a factor of 2. FSEA20 without option FSE-B4: Residual modulation is higher by a factor of 20 (approx.). FSEB20, FSEM20, FSEK20 without option FSE-B4: Residual modulation is higher by a factor of 40 (approx.). RF > 1 GHz (all models): Residual modulation is additionally higher by a factor of $\sqrt{f}/1$ GHz; f=carrier frequency.

Incidental FM with AM ⁴⁾ demod. BW ≤200 kHz, m = 50%, f _{mod} = 1 kHz, lowpass 5% of demod. BW or 3 kHz	≤50 Hz + residual FM
Phase demodulation Range AF	up to 10 rad
Offline demodulation	DC/0.001 to 0.1 x demod. BW <(0.4 x demod. BW)/(phase deviation/rad)
Realtime demodulation	200 Hz to 0.1 x demod. BW, max. 15 kHz <(0.4 x demod. BW)/(phase devia- tion/rad), smaller limit values apply
Error	≤5% of result + residual φM
Distortion ⁴⁾ (real time demod.) RF ≤1 GHz, demod. BW ≥10 kHz, SINAD 1 kHz with phase deviation/rad = 0.2 x demod. BW/1 kHz, HP 300 Hz, LP 3 kHz	>50 dB
Residual φM ⁵⁾ Demod. BW ≤200 kHz, Offline demodulation ⁶⁾ lowpass 5% of demod. BW, rms	≤0.03 rad
Realtime demodulation HP 300 Hz, LP 3 kHz, rms	≤0.01 rad
Incidental φM with AM ⁴⁾ demod. BW ≤200 kHz, m = 50%, f _{mod} = 1 kHz, lowpass 5% of demod. BW or 3 kHz	≤0.05 rad + residual φM
Measurement of unmodulated carrier power Measurement error (ref. level to ref. level -30 dB)	1.5 dB

⁶⁾ Contrary to note ⁵⁾ data are valid for RF ≤100 MHz. For RF >100 MHz residual modulation is higher by a factor of f/100 MHz; f=carrier frequency.

SINAD measurements Realtime demodulation AF = 1 kHz ± 4 x 10 ⁻⁴ x demod. BW error with 6 to 54 dB SINAD	±1 dB + error due to demodulator SINAD
Display of AF frequencies Range	Offline demodulation 0.001 to 0.3 x demod. BW Realtime demodulation 30 Hz to 0.3 x demod. BW, max. 20 kHz
Resolution Error (S/N ≥40 dB)	1 mHz to 1 Hz 1 x 10 ⁻⁶ x demod. BW + error of reference frequency + 1 mHz ± 1 digit
AF filters Realtime demodulation Lowpass	3 kHz, 15 kHz (Butterworth, 12 dB/oct.) 30 Hz, 300 Hz (6 dB/oct.) CCITT P.53, C message
Highpass Weighting filters Offline demodulation Lowpass	5%, 10%, 25% of demod. BW, (12 dB/oct.)

General data: see data sheet Spectrum Analyzers FSE

Order designations

Spectrum Analyzer 9 kHz to 3.5 GHz	FSEA20	1065.6000.20
Spectrum Analyzer 20 Hz to 3.5 GHz	FSEA30	1065.6000.30
Spectrum Analyzer 9 kHz to 7 GHz	FSEB20	1066.3010.20
Spectrum Analyzer 20 Hz to 7 GHz	FSEB30	1066.3010.30
Spectrum Analyzer 9 kHz to 26.5 GHz	FSEM20	1080.1505.20
Spectrum Analyzer 20 Hz to 26.5 GHz	FSEM30	1079.8500.30
Spectrum Analyzer 9 kHz to 40 GHz	FSEK20	1088.1491.20
Spectrum Analyzer 20 Hz to 40 GHz	FSEK30	1088.3494.30
Vector Signal Analyzer Option for Spectrum Analyzers FSE	FSE-B7	1066.4317.02
Low Phase Noise and OCXO Option (for models 20)	FSE-B4	1073.5396.02

Further options and accessories

See data sheet Spectrum Analyzers FSE, Order No. PD 757.1519



ROHDE & SCHWARZ GmbH & Co. KG · Mühldorfstraße 15 · 81671 München

P.O.B. 8014 69 · 81614 München · Telephone +4989 41 29-0 · Fax +4989 41 29-35 67 · Internet: <http://www.rsd.de>