

MS8604A

Digital Mobile Radio Transmitter Tester

100 Hz to 8.5 GHz



High-Speed Tester for NADC/PDC/PHS

Burst Modulation Accuracy Measured in Under ONE Second



Fast, Accurate Measurement of Digital Modulated Signals



The MS8604A is a full-featured digital mobile transmitter tester for evaluating the major characteristics of transmitters used in the North-American Digital Cellular Systems (NADC), Japan's digital mobile telephone (PDC: Personal Digital Cellular) system and by cordless telephones (PHS: Personal Handy Phone System). It covers frequencies from 100 Hz to 8.5 GHz, and measures spurious emissions over a broad frequency range. It can also measure RF signals directly up to 10 W (average burst power) and base-band devices can be evaluated using its I/Q signal input function (option). The MS8604A is ideal for high-speed measurement of frequency deviation, spurious emissions, occupied bandwidth, antenna power, leakage power during carrier-off, transmission ramp-up and ramp-down power, modulation accuracy, leakage power of adjacent channel, and signal transmission rate of digital mobile transmitters. In addition to measurements conforming to EIA/TIA, ETSI, RCR, and MKK standards,

DSP (digital signal processing) and high-speed measurement function based on a unique measurement algorithm combine to greatly reduce the time required for manufacturing and inspecting transmitters. PTA functions enabling free programming of test procedures are provided as a standard feature.

- Major transmitter functions evaluated by single system
- Compatible with NADC/PDC/PHS systems (compatibility with single system provided as standard; optional expansion to all three systems)
- High-speed measurement (under 1 second for modulation-accuracy measurements)
- Input up to 10 W (internal 20 dB attenuator and power meter for high power levels)
- Superior operability
- I/Q signal input (option)

Unique High-Speed Measurement Method

A unique high-speed measurement method is available for measuring occupied bandwidth and leakage power of adjacent channel in addition to RCR (Research & Development Center for Radio Systems) standards and Specifications for the type approval test of the Ministry of Posts and Telecommunications of Japan. For RCR standards, a spectrum analyzer is used to determine the occupied bandwidth and leakage power of adjacent channel from the burst signal frequency spectrum. In this method, frequency sweeps must be

performed slowly to obtain an accurate burst wave spectrum, so measurement speed falls. For example, more than 10 seconds are required when measuring PDC. With Anritsu's unique measurement method, digital signal processing is used to compute the frequency components from a single burst signal waveform, and the occupied bandwidth and leakage power of adjacent channel are computed from the results. Measurement times of 2 seconds and less are possible for PDC transmitters.

MS8604A

Evaluation of Digital Mobile Transmitters

Automated Measurement by Simple Key Operations

Quick Configuration for Different Communication Systems

Measurement software for one communication system is provided as a standard feature; others can be added as options. When these options are chosen, the communication system can be selected by pressing a single key.



One-Touch Selection of Measurement Items

Measurement items can be selected by pressing a single key. The input connector (RF/IO), maximum input power, and type of signal for measurement (uplink/downlink, number of slots per carrier, channel number/frequency, frequency steps, synchronizing words, root Nyquist filter switching) can be preset. In particular, synchronizing words can be predefined to any value. Measurement can be performed in either the single-measurement mode (one measurement performed each time key pressed), or in the automatic continuous repeat mode.



Measurement of Frequency, Modulation Accuracy, Signal Transmission Rate

Both absolute frequencies and deviations can be read directly. Measurement of modulation accuracy includes both vector errors within burst signals, amplitude errors, phase errors, origin offset and droop factors, and vector errors for first ten symbols immediately following startup. Ten-burst averages and signal transmission rates can also be measured.

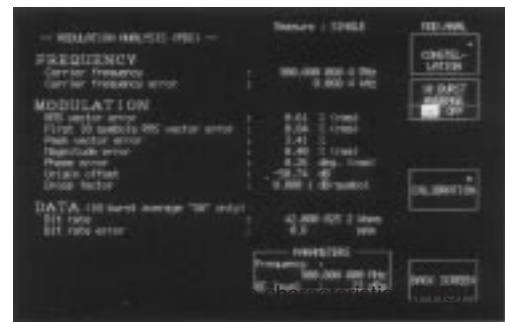

Measurement of Antenna Power and Leakage Power during Carrier-Off

At measurement of burst signal antenna power, the power-on intervals are auto-detected based on the modulated wave, so an external synchronization trigger is not needed. In addition, the average power during power-on intervals is automatically matched to a template value, simplifying measurement automation. Any template can be set, and three types can be stored. The leakage power during carrier-off can be measured as either an absolute value or as an on/off ratio. When the carrier-off power is low, measurements can be performed in a wide-dynamic-range mode (during single-mode measurements with synchronizing word).

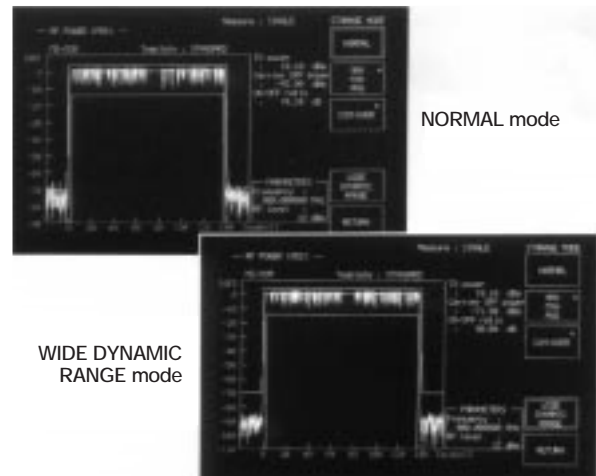

Measurement of Transmission Ramp-up and Ramp-down Power

Transmission ramp-up and ramp-down power can be measured simultaneously with antenna power measurements. In addition, the marker points can be moved and the marker point symbol power can be read directly.

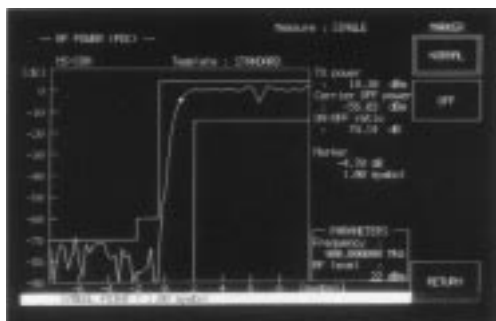

Measurement of Occupied Bandwidth

Users can select either a standard mode using spectrum-analyzer methods, or a high-speed mode to reduce measurement time.

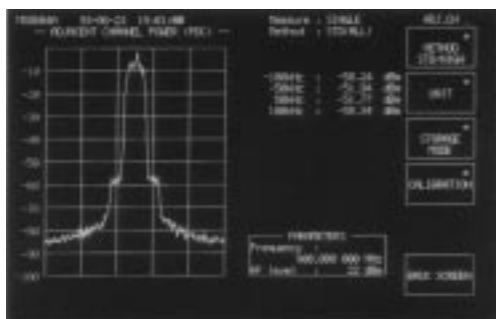

Measurement of Leakage Power of Adjacent Channel

Users can select either a standard mode using spectrum-analyzer methods, or a high-speed mode to reduce measurement time.

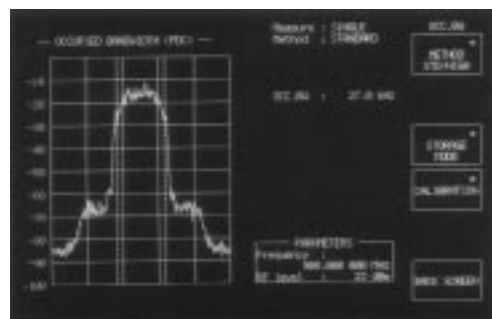

Measurement of Spurious Emissions

Up to 15 spurious measurement frequencies can be stored in one memory table and three memory tables are provided. In addition, a function is provided for automatic measurement of the highest level within a ± 500 kHz range of a specified frequency. By using spectrum-analysis functions, spurious emissions can be detected over a wide frequency range.



• Measurement Times

Measurement item	NADC	PDC	PHS
Frequency, modulation accuracy (simultaneous)	≤1s		
Spurious emissions (15 specified waves)	approx. 9s (fixed frequencies), approx. 40s (search within ± 500 kHz)		approx. 9s (fixed frequencies), approx. 25s (search within ± 500 kHz)
Occupied bandwidth	—	approx. 12s (standard mode), ≤1s (high-speed mode)	approx. 4s (standard mode), ≤1s (high-speed mode)
Antenna power, leakage power during carrier-off, transmission ramp-up and ramp-down power (simultaneous)	≤1s		
Leakage power of adjacent channel	≤2s	approx. 13s (standard mode), ≤1.5s (high-speed mode)	approx. 5s (standard mode) ≤1.5s (high-speed mode)
Signal transmission rate	≤3s		≤2s

Note: Measurement times are for continuous measurement under identical conditions and settings.

For High-Speed Analysis of Digital Modulated Waveforms

Convenient for Real-time Analysis of RF, IF, I/Q Signal Constellation, Evaluation and Adjustment of Modulation Circuits

Constellation Display Function

The I/Q vector components of measured signals are displayed as symbol points. The frequency error, RMS/PEAK vector error, and origin offset can also be displayed on the same screen.



The modulation error can be found by connecting the I/Q vector components of symbol points.



Intervals between symbol points are smoothly interpolated for dynamic observation of the movement of I/Q vector components.



Scaled Modulation Error Display

The modulation error scale can be switched between 5%, 10% and 20%, and can be displayed for each symbol point—a useful feature when making decisions on modulation accuracy.



Full Spectrum Analysis Functions

Zone Marker

Zone marker reduce measurement time. A marker is automatically set at the signal peak just by setting the received signal in zone marker. Zone marker can be used to set the zone position and width freely.

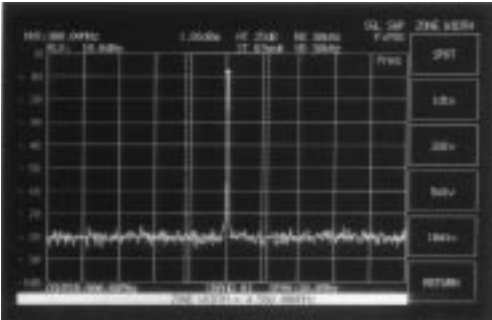

Zone Sweeping

The region inside the zone marker is swept repeatedly. For example, if a zone width of 1 division is set, sweeping is 10 times faster than for a full sweep.

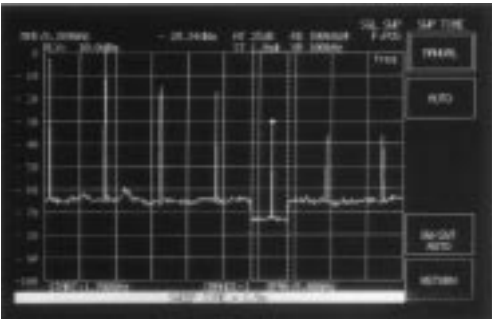

Multimarker

The multimarker feature displays up to ten markers on the measured waveform, and simultaneously lists the frequencies and levels at the marker points. The multimarker feature includes harmonic measurement, measurement of the highest ten points, and manual setting function.

Harmonic measurement: For measurement of high harmonic spurious emissions; markers are set automatically at integer multiples of the carrier frequency, and the frequencies and levels at the marker points are displayed.

Measurement of highest ten points: Markers are set automatically at the ten points with the highest levels on the screen, and the frequencies and levels at each of the marker points are displayed.

Manual setting function: Up to ten markers can be set manually at any frequency.



High-Precision Power-Meter Functions

Precise Measurement of Antenna Power by Power-Meter Method

Direct Measurement with Broadband Power Sensor

The tester has a high-performance power meter comparable to the Anritsu ML4803A. A broadband amorphous-element power sensor is coupled directly for high-precision measurement.

Three Measurement Modes

In addition to absolute values in W and dBm, relative values are also displayed in dB.



USER CAL FACTOR Input

When losses from connecting cables and external attenuators are input as the "USER CAL FACTOR," displayed results are corrected by the factor. And, the burst average power can be displayed by setting a burst wave duty factor for correction.

Internal Calibration Signal

An internal 1 mW calibration signal is provided for calibrating the sensitivity of the power sensor automatically by pressing the CAL ADJUST key.

High-Power Measurements

Antenna power up to 10 W max. (burst average power) can be measured directly using the internal high-power attenuator. This high-power attenuator is pre-calibrated, for accurate measurement of transmitter power levels.

Intuitive Key Layout, Simple Operation

Separate Functions for Transmitter Tests and Spectrum Analysis

Just pressing the TxTest key produces rapid measurement results by category. And spectrum-analyzer functions can be selected with the Spectrum key for signal spectrum analysis.

- 1 Function keys provide one-touch selection of measurement items during transmitter testing.
- 2 These keys select single or repeated measurements.
- 3 Press the TxTest key to evaluate transmitters, and the Spectrum key for spectrum analysis.
- 4 For hard-copying the screen display. In addition, four parameter settings can be saved and recalled.
- 5 Keys for entering alphanumeric characters, units and other items.
- 6 PMC (Plug-in Memory Card) slot
 - ▶ The save/recall function can be used to save/recall parameter settings to/from the PMC
 - ▶ PTA programs can be saved and loaded
 - ▶ PMCs can be written and read as data files during PTA program execution



MS8604A

Digital Mobile Radio
Transmitter Tester

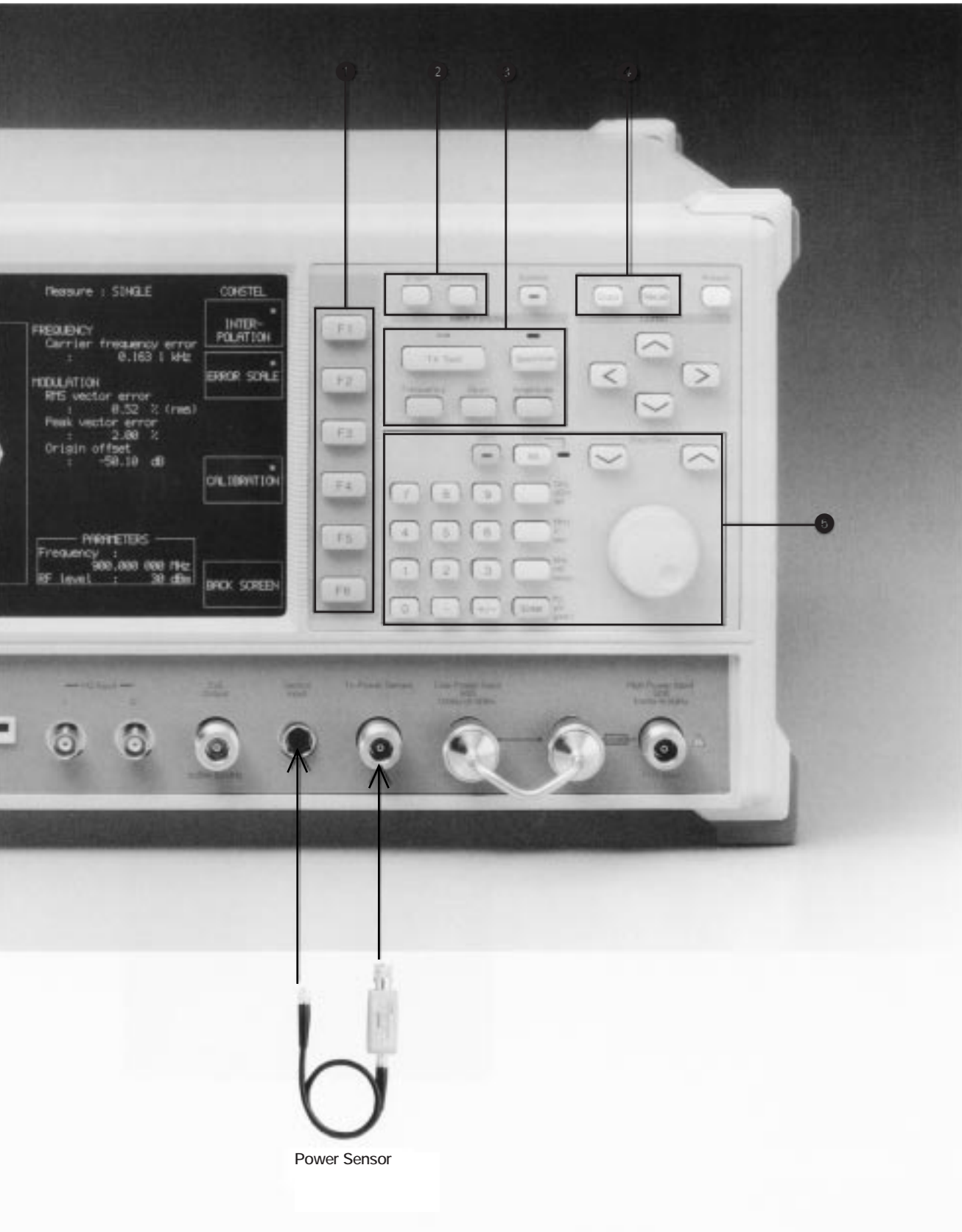

Power Sensor

Measurement Software and Measurement Items

◆ Option 11: Measurement Software for PDC (Personal Digital Cellular)

Measurement Item	RCR STD-27B	Type Approval Test*1	Anritsu High-Speed Measurement Method
Frequency deviation	✓	✓	
Strength of spurious emissions	✓	✓	✓
Occupied bandwidth	✓	✓	✓
Antenna power deviation	✓	✓	
Leakage power during carrier-off	✓	✓	
Transmission ramp-up and ramp-down power	✓	—	
Modulation accuracy	✓	—	
Leakage power of adjacent channel		✓	✓
Signal transmission rate			✓

◆ Option 12: Measurement software for PHS (Personal Handy Phone System)

Measurement Item	RCR STD-28	Anritsu High-Speed Measurement Method
Frequency deviation	✓	
Strength of spurious emissions	✓	✓
Occupied bandwidth	✓	✓
Antenna power deviation	✓	
Leakage power during carrier-off		✓
Transmission ramp-up and ramp-down power	✓	
Modulation accuracy	✓	
Leakage power of adjacent channel	✓	✓
Signal transmission rate		✓

◆ Option 13: Measurement software for NADC (North American Digital Cellular Systems)

Measurement Item*2	EIA/TIA IS-55
Frequency stability	✓
Modulation accuracy	✓
Carrier switching time	✓
RF power output	✓
Adjacent and alternate channel power due to modulation	✓
Out of band power arising from switching transients	✓
Harmonic and spurious emissions	✓
Time alignment	

✓ : Measurement method for use with MS8604A

— : Measurements not included in method for type approval test by the Ministry of Posts and Telecommunications of Japan

*1 : Method for type approval test by the Ministry of Posts and Telecommunications of Japan

*2 : Items only for digital systems

PTA Automated Measurement System

MS8604A-Based Automated Measurement Systems

The MS8604A includes PTA (Personal Test Automation) programming functions as a standard feature. PTA is a personal computer function that allows the user to write simple programs to the function keys for controlling external devices and performing sophisticated measurements. PTA offers outstanding flexibility as a personal specialized automated measurement system.

Measurement with one original card

Programs written while checking the measurement procedure can be stored in the nonvolatile memory in the MS8604A or saved on the PMC (Plug-in Memory Card). A new card is made every time the user develops a new measurement function, thus making it possible to organize functions by cards.

In addition to programs, measurement data and program control variables can also be stored on PMCs.



Full-Featured Interface for Configuring Optimum System

Two-Port GP IB System

The MS8604A has two GP IB ports as standard equipment. Consequently, a PTA-automated measurement system can be expanded to a system controlled by a host. PTA-based distributed processing offers greater efficiency than systems in which several instruments are under the central control of a host.

Three-Port Interface

The MS8604A is available parallel I/Q interface and an optional RS-232C interface in addition to the two GP IB interface for configuring the ideal PTA-automated measurement system from numerous possible combinations.

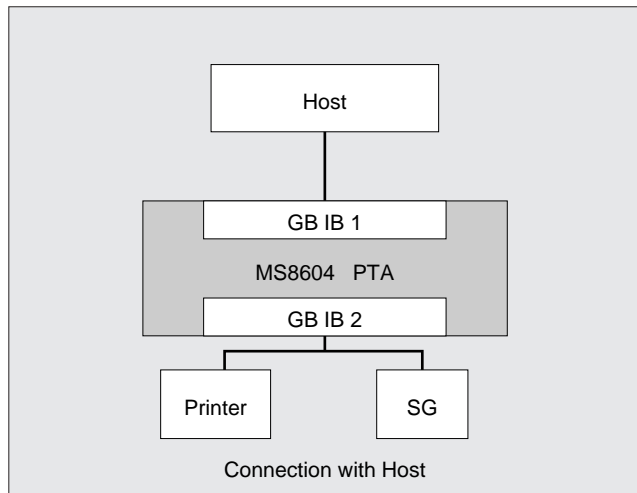

I/Q Oscillator Evaluation (using option 03)

The modulation accuracy, amplitude and occupied bandwidth of an I/Q oscillator can be evaluated.

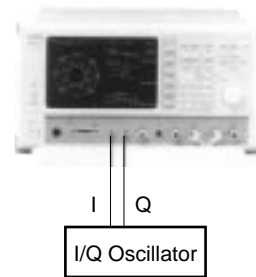

Evaluation of Transceiver Characteristics by PTA Control

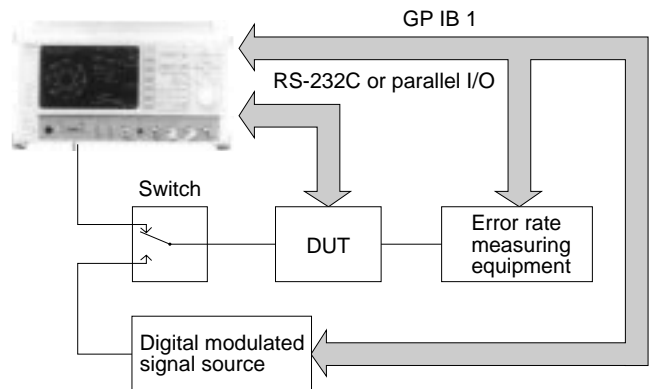

Parallel I/O Application Examples

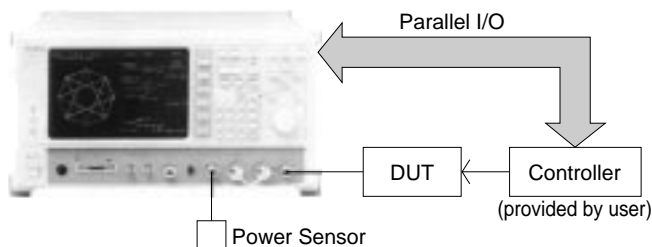

Measurement items

- | | |
|--|--|
| Antenna power (spectrum-analyzer method, power-meter method) | Spurious emissions |
| Frequency deviation (phase-trace method) | Leakage power during carrier-off |
| Occupied bandwidth | Modulation accuracy |
| Leakage power of adjacent channel | Signal transmission rate |
| | Transmit power control characteristics |

Specifications

GENERAL	Frequency Range	100Hz to 8.5 GHz		
	Max. Input Level (Continuous wave average power)	+40 dBm (10 W)		
	Reference Oscillator	Frequency: 10 MHz Starting characteristics: $\leq 5 \times 10^{-8}$ (option: $\leq 2 \times 10^{-8}$, after 30 min. warm-up) *After 10 min. of warm-up, compared to the frequency after 24 hour warm-up Aging rate: $\leq 2 \times 10^{-8}$ /day(option: $\leq 5 \times 10^{-9}$ /day), $\leq 1 \times 10^{-7}$ /year (option: $\leq 5 \times 10^{-8}$ /year) *Compared to the frequency after 24-hour warm-up Temperature characteristics: 5×10^{-8} (option: 3×10^{-8}) *0' to 50°C, relative to the frequency at 25°C		
Applicable Systems	NADC (option 13)	PDC (option 11)	PHS (option 12)	
	Specifications below guaranteed after pressing key for optimizing internal level			
TRANSMITTER	Frequency range	400 kHz to 2.1 GHz	400 kHz to 2.1 GHz	10 MHz to 2.1 GHz
	Input level	-10 to 40 dBm (burst average power) When using the low power-input connector, measurement to levels 20 dB lower than the above values is possible.		
	Frequency accuracy	\pm (Accuracy of reference oscillator +1 Hz)		\pm (Accuracy of reference oscillator +10 Hz)
	Modulation accuracy	\pm (2% of indicated value +0.5%)		\pm (2% of indicated value +0.7%)
	Origin offset accuracy	\pm 0.5 dB to signal level of -30 dBc		
	Transmission rate accuracy	\pm 1 ppm		
	Measuring range of transmission rate	48.6 kbps \pm 100 ppm	42 kbps \pm 100 ppm	384 kbps \pm 100 ppm
	Waveform display	Constellation display		
	Measurement time	\leq 1 s (except transmission rate measurement) \leq 3 s (transmission rate measurement)		\leq 1 s (except transmission rate measurement) \leq 2 s (transmission rate measurement)
	MEASUREMENT	Frequency range	10 MHz to 2.1 GHz	
Input level range		+10 to +40 dBm (Average power of burst signal)		
Transmission power accuracy		\pm 10% (using high-power input after calibration with Power Sensor MA4601A)		
Carrier-off power		Measurement range in NORMAL mode: \geq 65 dB (To average power of burst signal) Average noise level in Wide dynamic range mode: \leq -60 dBm (100MHz \leq Freq. \leq 2.1GHz) *Measurement range is \geq 96 dB for +36 dBm input level of average power of burst signal	Measurement range in NORMAL mode: \geq 65 dB (To average power of burst signal) Average noise level in Wide dynamic range mode: \leq -60 dBm (100 MHz \leq Freq. \leq 2.1 GHz) *Measurement range is \geq 95 dB for 3 W input level of average power of burst signal.	Measurement range in NORMAL mode: \geq 55 dB (To average power of burst signal) Average noise level in Wide dynamic range mode: \leq -50 dBm (100 MHz \leq Freq. \leq 2.1 GHz) *Measurement range is \geq 69 dB for 10 mW average power (Burst average power: 80 mW).
Rise/fall edge characteristics		Displays rising/falling edges while synchronizing modulation data of measured signal.		
Measurement time		\leq 1 s		
Impedance		50 Ω (VSWR: \leq 1.2)		
Occupied Bandwidth Measurement	Frequency range	10 MHz to 2.1 GHz		
	Input level range	+10 to +40 dBm (Average power of burst signal)		
	Standard mode (Spectrum analyzer mode)	Measurement: Displays results of occupied bandwidth measurement after measuring signal with spectrum analyzer Measurement time: Approx. 12 s in full rate when number of data points set to NORMAL		Measurement: Displays results of occupied bandwidth measurement after measuring signal with spectrum analyzer Measurement time: Approx. 4 s when number of data points set to NORMAL
	High-speed mode	Measurement: Displays results of occupied bandwidth measurement after FFT of measured signal Measurement time: \leq 1 s		

Applicable Systems		NADC (option 13)	PDC (option 11)	PHS (option 12)	
T R A N S M I T T E R M E A S U R E M E N T	Frequency range	100 MHz to 2.1 GHz			
	Input level range	+10 to +40 dBm (Average power of burst signal)			
	Measurement	Spectrum analyzer mode: Displays results of leakage power of adjacent channel measurement after measuring signal with spectrum analyzer Measurement time: Approx. 13 s in full rate when number of data points set to Normal High-speed mode: Displays results of leakage power of adjacent channel measured after passing signal through internal root-Nyquist filter Measurement time: ≤ 2 s	Standard mode: Displays results of leakage power of adjacent channel measurement after measuring signal with spectrum analyzer Measurement time: Approx. 13 s in full rate when number of data points set to Normal in All mode High-speed mode: Displays results of leakage power of adjacent channel measured after passing signal through internal root-Nyquist filter Measurement time: ≤ 1.5 s	Standard mode: Displays results of leakage power of adjacent channel measurement after measuring signal with spectrum analyzer Measurement time: Approx. 5 s when number of data points set to Normal in All mode High-speed mode: Displays results of leakage power of adjacent channel measured after passing signal through internal root-Nyquist filter Measurement time: ≤ 1.5 s	
	Measurement range	High speed mode: ≥ 30 dB (30 kHz offset) ≥ 60 dB (60 kHz offset) ≥ 65 dB (90 kHz offset) *Ratio of average power of burst signal to average value of leakage power of adjacent channel at burst-on time	Standard mode: ≥ 60 dB (50 kHz offset) ≥ 65 dB (100 kHz offset) High-speed mode: ≥ 60 dB (50 kHz offset) ≥ 65 dB (100 kHz offset) *In High-speed mode, ratio of average power of burst signal to average value of leakage power of adjacent channel at burst on time	Standard mode: ≥ 60 dB (600 kHz offset) ≥ 60 dB (900 kHz offset) High-speed mode: ≥ 60 dB (600 kHz offset) ≥ 65 dB (900 kHz offset) *In High-speed mode, ratio of average power of burst signal to average value of leakage power of adjacent channel at burst on time	
S P U R I O U S M E A S U R E M E N T	Frequency range	10 MHz to 8.5 GHz Except frequency range ± 1 MHz of carrier frequency		10 MHz to 8.5 GHz Except frequency range ± 50 MHz of carrier frequency	
	Input level range: (Transmission power)	+10 to +40 dBm (Average power of burst signal)			
	Measurement range	≥ 65 dB (10 MHz to 1.7 GHz) ≥ 75 dB (1.7 to 8.5 GHz) At carrier frequency range 800 MHz to 1.7 GHz		≥ 60 dB (10 MHz to 1.7 GHz) ≥ 70 dB (1.7 to 8.5 GHz) At carrier frequency range 800 MHz to 2.1 GHz	
I/Q input (option 03)	Input level range: 0.3 to 1.5 Vp-p Input impedance: 5 k Ω , AC/DC coupling (switchable) Measurement items: Modulation, Amplitude, Occupied bandwidth				
S P E C T R U M A N A L Y Z E R	Frequency	Setting range: 100 Hz to 8.5 GHz (resolution: 1 Hz), 0 to 2 GHz (freq. band: 0) 1.7 to 7.5 GHz (freq. band: 1-), 6.5 to 8.5 GHz (freq. band 1+) Preselector range: 1.7 to 8.5 GHz (bands: 1-/1+) Display accuracy: \pm (Displayed freq. x Reference freq. accuracy + Span x Span Accuracy) Span: Setting range: 0 Hz, 100 Hz to 8.5 GHz Accuracy: $\pm 2.5\%$ (Span ≥ 1 kHz), $\pm 5\%$ (100 Hz \leq Span < 1 kHz) RBW: Setting range: 10 Hz to 3 MHz (3 dB), 1-3 sequence Accuracy: $\pm 20\%$ Selectivity (60/3 dB), $\leq 15:1$ (100 kHz to 3 MHz), $\leq 12:1$ (10 Hz to 30 kHz) VBW: 1 Hz to 3 MHz, Off, 1-3 sequence Signal purity (SSB, 1 MHz to 4 GHz): ≤ -100 dBc/Hz (10 kHz offset), ≤ -115 dBc/Hz (50 kHz offset), ≤ -120 dBc/Hz (100 kHz offset)			
	Amplitude	Level measurement	Level measuring range: Average noise level to +40 dBm Average noise level: ≤ -112 dBm (10 MHz to 8.5 GHz, RBW 10 Hz, VBW 1 Hz, Input att. setting 20 dB) Residual response: ≤ -75 dBm (1 MHz to 8.5 GHz, Input att. setting 20 dB)		
		Reference level	Setting range: -80 to +40 dBm Accuracy: ± 0.5 dB (-30 to +20 dBm), ± 0.75 dB (-40 to -30 dBm, +20 to +40 dBm), ± 1.5 dB (-60 to -40 dBm) After calibration and at Freq. 100 MHz, Span ≤ 2 MHz, and in Auto mode for Input att, RBW, VBW and Sweep time settings RBW switching error (after calibration): ± 0.3 dB (RBW: ≤ 300 kHz), ± 0.7 dB (RBW: ≥ 1 MHz) LOG/LIN switching error: ± 0.3 dB (after calibration) Input attenuator: Setting range: 20 to 75 dB in 5 dB steps Switching error: ± 0.3 dB (referred to input att. 30 dB, at 100 MHz)		
		Frequency response	± 0.5 dB (100 MHz to 2 GHz, band: 0), ± 1 dB (1.7 to 8.5 GHz, bands: 1-/1+) *Referred to at 100 MHz, Input att. 30 dB, temperature 18° to 28°C (after tuning Preselector at bands 1-/1+)		

Applicable System		NADC (option 13)	PDC (option 11)	PHS (option 12)	
S P E C T R U M A N A L Y Z E R	Linearity (after calibration)	LOG: ± 0.3 (0 to -20 dB, RBW: ≤ 1 MHz), ± 1 dB (0 to -60 dB, RBW: ≤ 100 kHz), ± 1.5 dB (0 to -80 dB, RBW: ≤ 10 kHz) LIN: $\pm 5\%$ (to reference level)			
	Dynamic range	2nd harmonics: ≤ -70 dBc (5 to 800 MHz, band: 0, mixer input level: -30 dBm) ≤ -80 dBc (800 to 850 MHz, band: 0, mixer input level: -30 dBm) ≤ -90 dBc (850 MHz to 2.1 GHz, bands: 1-/-1+, mixer input level: -10 dBm) Two-single third-order intermodulation distortion: ≤ -70 dBc (10 to 50 MHz), ≤ -85 dBc (50 MHz to 2.1 GHz), *Frequency difference between two signals ≥ 50 kHz, mixer input level -30 dBm			
	Spurious	Image response: ≤ -70 dBc Multiple-response: ≤ -70 dBc (bands: 1-/-1+)			
	Sweep	Sweep time: Setting range: 20 ms to 1000 s (TRACE-FREQ., Data points: NORMAL), 50 ms to 1000 s at other conditions Accuracy: $\pm 10\%$ (20 ms to 200 s), $\pm 15\%$ (200 to 1000 s) Sweep mode: CONTINUOUS, SINGLE Trigger: FREE RUN, TRIGGERED Trigger source: VIDEO, LINE, EXT (± 10 V), EXT (TTL) Gate mode (OFF, Random sweep mode): GATE DELAY: 0 to 65.5 ms (in 1 μ s steps, GATE END: INT) GATE END: INT/EXT			
	Time domain waveform display	Sweep time: 50, 100 to 900 μ s (Data point: NORMAL, One most significant digit can be set.) 1 ms to 1000 s (Data point: NORMAL, two most significant digits can be set.) 100, 200 to 800 μ s (Data point: DOUBLE, One most significant digit can be set as even number.) 1 ms to 1000 s (Data point: DOUBLE, Two most significant digits can be set as even number) Delay time: Pre-trigger: -time span to 0 s (in 1-point steps) Post trigger: 0 to 65.5 ms (in 1 μ s steps) Amplitude display resolution: 50 μ s to 49 ms, 10 bits (0.1% of full scale) 50 ms to 1000 s, 14 bits (0.01% of full scale)			
	Detection mode	POS PEAK, SAMPLE, NEG PEAK			
	Number of points	NORMAL: 501 points, DOUBLE: 1002 points			
	AM/FM demodulation	Demodulated waveform display and monitoring demodulated audio signal with internal speaker			
Auxiliary inputs/outputs	IF output 21.4 MHz: -10 dBm ± 2 dB (at top of screen, with output terminated by 50 Ω terminator.) Y output: 0 to 0.5 V ± 0.1 V (at range between top and bottom of screen, LOG: 10 dB/div., LIN: 10% div., 100 MHz and with output terminated by 75 Ω terminator), BNC connector External trigger input: Input 1: Max. ± 10 V (in 0.1 V steps, rising/falling edge, selectable and pulse width ≥ 10 μ s), BNC connector Input 2: TTL level (Rising/falling edges, selectable and pulse width ≥ 10 μ s), BNC connector				
P O W E R	Frequency range	100 kHz to 5.5 GHz			
	Level range	-20 to +20 dBm			
	Instrumentation accuracy	$\pm 0.5\%$			
	Zero set	$\pm 0.5\%$ of full scale at most sensitive range (100 μ W range)			
	Zero shift between ranges	$\pm 0.2\%$ of full scale after zero setting at most sensitive range			
	Calibration oscillator	Freq.: 50 MHz, Out: 1.00 mW, Accuracy $\pm 1.2\%$			
Applicable Power Sensor	MA4601A				
M E T E R	Display	640 x 400-dot, 9-inch EL			
	Inputs/outputs on rear panel	Reference input: 10 MHz ± 10 Hz, 2 to 5 Vp-p, $\geq 50\Omega$, BNC connector Reference buffer output: 10 MHz, 2 to 3 Vp-p (with the output terminated by a 200 Ω terminator), BNC connector Separate video output: Compatible with 8-pin DIN connector			
	External memory	One slot can be connected.			
	Save/recall	Internal memory (4 sets of spectrum and Tx test conditions), Can save/recall setting conditions at external memory (PMC)			
	Direct plotting	Can hard-copy screen via GP IB2			
	External control	GP IB 1 (IEEE 488.2)	As device controlled by host, all functions except power switch Control other instruments as controller using PTA SH1, AH1, T6, L4, SR1, RL1, PPO, DC1, DT1, CO (C1, C2, C3 and C24 with PTA)		
		GP IB 2 (IEEE 488.1)	Control other instruments as controller SH1, AH1, T6, L4, SR1, RL1, PPO, DCO, DTO, C1, C2, C3, C4, C28		
		I/O port	Output port A/B: 8-bit (TTL level), Input/Output port C/D: 4-bit (TTL level), Exclusive port: 3-bit (TTL level) Control signal: 4 (TTL level), +5V output: max. 50mA		
		RS-232C (option 02)	Control other instruments as controller		
	PTA	Language	PTL: High level language interpreter based on BASIC		
Programming		Using external keyboard			
Program memory		On PMC or FD Upload/Download from/to PC			
Programming capacity	900 Kbytes				
Operating Temperature	0° to 50°C				
Power	85 to 132/170 to 250 Vac, 47.5 to 63 Hz, ≤ 500 VA				
Dimensions and mass	221.5 H x 426 W x 451 D mm, < 27 kg				
EMC ^{*1}	EN55011: 1991, Group 1, Class A EN50082-1: 1992				

*1 EMC : Electromagnetic Compatibility

Ordering Information

Please specify the Model/Order No., names, and quantities when ordering.

Model/Order No.	Name	Remarks
MS8604A	Main frame Digital Mobile Radio Transmitter Tester	
	Standard Accessories	
J0114A	Coaxial cord, 1m:	1pc. UG-21D/U•RG-9A/U•UG-21D/U
J0017F	Power cord, 2.5m:	1 pc.
P0005	PMC:	1 pc. BS32F1-C-172, 32 Kbytes
MA4601A	Power Sensor:	1 pc. 100 kHz to 5.5 GHz, -30 to +20 dBm
J0370N	Power Sensor Connector Cable, 0.5m	1 pc.
F0014	Fuse, 6.3A:	2pcs. T6.3A250V
W0682AE	MS8604A Operation Manual:	1 pc.
	Options	
MS8604A-01	Reference quartz oscillator	Aging rate: $\leq 5 \times 10^{-9}$ /day
MS8604A-02	RS-232C Interface (for external control)	
MS8604A-03	I/Q input	
MS8604A-11	Measurement software Ver.3 (PDC)	} Added to the MS8604A firmware at the factory
MS8604A-12	Measurement software Ver.3 (PHS)	
MS8604A-13	Measurement software Ver.3 (NADC)	
MS8604A-14	Measurement software Ver.2 (Digital MCA)	
MS8604A-15	Measurement software Ver.2 (GMSK)	
MS8604A-16	Measurement software ($\pi/4$ DQPSK)	
W0722AE	Measurement software operation manual	Supplied with Option 14
W0876AE	Measurement software operation manual	Supplied with Option 15
W0973AE	Measurement software operation manual	Supplied with Option 16
Z0251A	MS8604A service kit	
	Application software	Supplied with PMC (Plug-in Memory Card)
MX3512A	$\pi/4$ DQPSK Analysis Software	For MS8604A-11/12/13
MX3513A	Digital MCA Analysis Software	For MS8604A-14
MX3518A	GSM Application Software	For MS8604A-15
MX3519A	DECT Application Software	For MS8604A-15
MX3520A	CT2 Application Software	For MS8604A-15
	Peripheral Equipment and Parts	
MC3305A	JIS type PTA keyboard	
MC3306A	ASCII type PTA keyboard	
VP-870	Printer	with GP-IB (EPSON product)
J0007	GP IB Cable, 1m	408JE-101
J0008	GP IB Cable, 2m	408JE-102
P0006	PMC, 64 KB	BS64F1-C-173
P0007	PMC, 128 KB	BS128F1-C-174
P0008	PMC, 256 KB	BS256F1-C-1175
P0009	PMC, 512 KB	BS512F1-C-1176
MA4001A	Range Calibrator	
MN1607A	50 Ω Coaxial Switch	DC to 3 GHz, 50 Ω (externally controlled)
MP59B	50 Ω Coaxial Switch	DC to 3 GHz, 50 Ω
MP640A	Branch	DC to 1.7 GHz, 40 dB
MP654A	Directional Coupler	0.8 to 3 GHz, 30 dB
MP520C	CM Directional Coupler	25 to 500 MHz, 50 Ω , N type
J0395	Fixed Attenuator for high-power	30 dB, 30W, DC to 8 GHz
J0055	Coaxial Adapter	NC-P•BNC-J
562	DC Block	10 MHz to 12.4 GHz (NARDA product)
B0329D	Protective Cover	
B0331D	Front Handle Kit	2 pcs/set
B0332	Joint Plates	4 pcs/set
B0333D	Rack Mount Kit	
B0334D	Hard Carrying Case	with protective cover casters



Specifications are subject to change without notice.

ANRITSU CORPORATION

5-10-27, Minamiazabu, Minato-ku, Tokyo 106-8570, Japan
Phone: +81-3-3446-1111
Telex: J34372
Fax: +81-3-3442-0235

Overseas Subsidiaries

● U.S.A.

ANRITSU COMPANY

North American Region Headquarters

1155 East Collins Blvd., Richardson, Tx 75081, U.S.A.
Phone: +1-972-644-1777
Fax: +1-972-644-3416

● Canada

ANRITSU ELECTRONICS LTD.

Unit 102, 215 Stafford Road West
Nepean, Ontario K2H 9C1, Canada
Phone: +1-613-828-4090
Fax: +1-613-828-5400

● Brasil

ANRITSU ELETRÔNICA LTDA.

Praia de Botafogo 440, Sala 2401 CEP 22250-040,
Rio de Janeiro, RJ, Brasil
Phone: +55-21-5276922
Fax: +55-21-537-1456

● U.K.

ANRITSU LTD.

200 Capability Green, Luton, Bedfordshire LU1 3LU, U.K.
Phone: +44-1582-433200
Fax: +44-1582-731303

● Germany

ANRITSU GmbH

Grafenberger Allee 54-56, 40237 Düsseldorf 1,
Germany
Phone: +49-211-96855-0
Fax: +49-211-96855-55

● France

ANRITSU S.A.

9, Avenue du Québec Z.A. de Courtabœuf 91951 Les
Ulis Cedex, France
Phone: +33-1-60-92-15-50
Fax: +33-1-64-46-10-65

● Italy

ANRITSU S.p.A.

Via Elio Vittorini, 129, 00144 Roma EUR, Italy
Phone: +39-06-502-26-66
Fax: +39-06-502-24-25

● Sweden

ANRITSU AB

Botvid Center, Fittja Backe 1-3 145 84 Stockholm,
Sweden
Phone: +46-853470700
Fax: +46-853470730

● Singapore

ANRITSU PTE LTD.

6, New Industrial Rd., #06-01/02, Hoe Huat Industrial
Building, Singapore 536199
Phone: +65-282-2400
Fax: +65-282-2533

● Hong Kong

ANRITSU COMPANY LTD.

Suite 719, 7/F., Chinachem Golden Plaza, 77 Mody
Road, Tsimshatsui East, Kowloon, Hong Kong, China
Phone: +852-2301-4980
Fax: +852-2301-3545

● Korea

ANRITSU CORPORATION

14F Hyun Juk Bldg, 832-41, Yeoksam-dong,
Kangnam-ku, Seoul, Korea
Phone: +82-2-553-6603
Fax: +82-2-553-6604-5

● Australia

ANRITSU PTY LTD.

Unit 3/170 Forster Road Mt. Waverley, Victoria, 3149,
Australia
Phone: +61-3-9558-8177
Fax: +61-3-9558-8255

● Taiwan

ANRITSU COMPANY INC.

6F, 96, Sec. 3, Chien Kou North Rd. Taipei, Taiwan,
R.O.C.
Phone: +886-2-2515-6050
Fax: +886-2-2509-5519