

MG3681A

Digital Modulation Signal Generator

250 kHz to 3 GHz



For Evaluating Next Generation Digital Mobile Communications Systems

For Wideband, High-speed Digital Mobile Communications

The MG3681A uses a wideband vector modulator to output the high-accuracy, high-speed vector modulation signals that are required for R&D and manufacturing of digital mobile communications equipment and related devices. It covers the frequency band of leading mobile communications systems for the frequency range of 250 kHz to 3 GHz.

It uses vector modulator to provide excellent frequency response, distortion and S/N ratio. It can perform accurate receiver sensitivity test and transmitter adjacent channel leakage power test for high-speed modulation communications systems.

Expansion units such as MU368040A CDMA Modulation Unit for modulation signals generation of W-CDMA communication system can be installed on the seven expansion slots in the MG3681A.

Various modulation signals can be generated with the expansion units and associated software.

The MG3681A also has analog modulation functions such as AM and FM for testing of analog communications systems. In addition, its excellent signal purity and various functions such as memory and frequency sweep are useful as a general-purpose signal generator.

12.00 13.00 14.00 15.00

- High-resolution Setting of Frequency 0.01 Hz and Output Level 0.01 dB
- 30 MHz Wideband and High-Accuracy Vector Modulation
- Excellent Adjacent Channel Leakage Power Ratio
- Various Expansion Units



Excellent Analog Basic Performance

Excellent Level Accuracy Signal

The frequency response is excellent by calibrating output level across the entire output RF frequency range. Even low level can be output with high-accuracy due to use of a high-precision, high-reliability step attenuator calibrated.

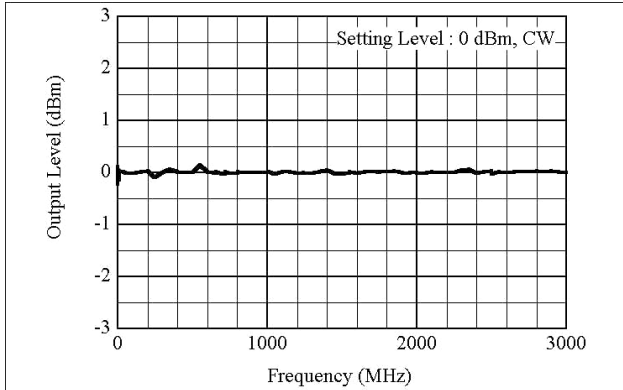

Output level frequency response

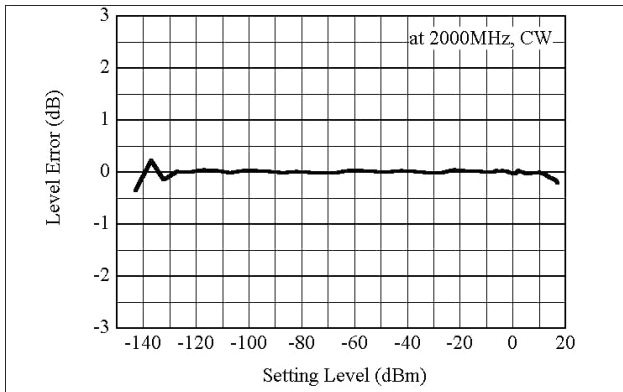

Output level accuracy

Excellent Signal Purity

Digital mobile communications evolve into wideband RF frequency bandwidth, and signal generator requires low-noise signal to faraway frequency offset. A unique synthesizer technology achieves low noise floor characteristics of -145 dBc/Hz (typ. at above 5 MHz offset).

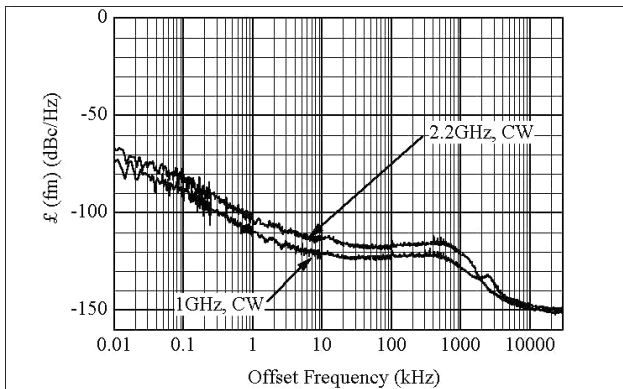

SSB phase noise characteristics

Wideband Vector Modulation

The modulation frequency response of ± 3 dB at the modulation frequency from DC to 30 MHz is achievable by the high-speed baseband signal processor and wideband vector modulator, permitting wideband vector modulation supporting high-speed data communications including W-CDMA system. Accurate wideband vector modulation is also available by using the external I/Q signals as well as internal modulation using the optional modulation units installed. In addition, a unique Automatic Level Control (ALC) technology assures stable output level at vector modulation.

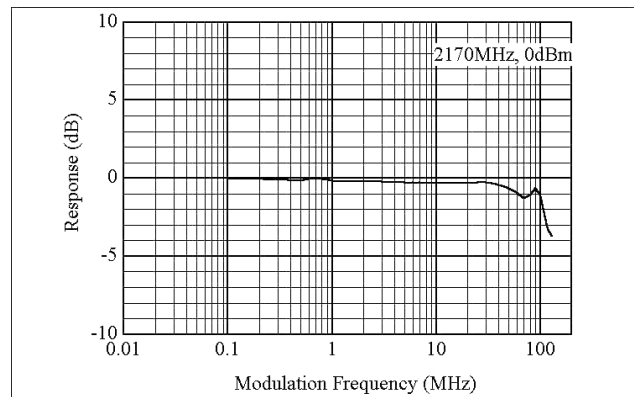

Vector modulation frequency response

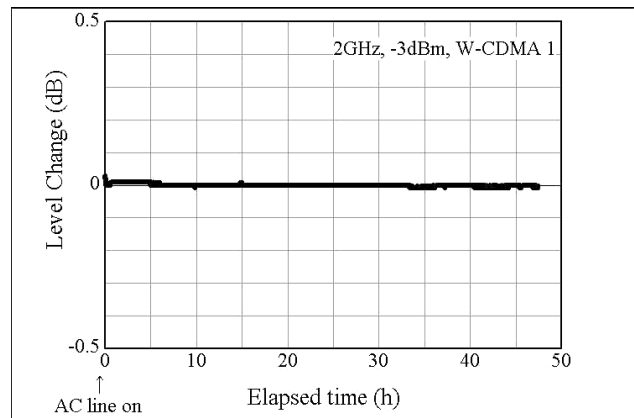

Output level stability at W-CDMA system modulation

Flexible System Configuration

Expansion Units for up to Seven Slots

Seven slots for expansion units have 14 bits high-speed waveform data bus each In-phase and Quadrature signals. The excellent expandable platform covers future communication systems by addition of expansion units.

Note: Some expansion units require installation of dedicated software to enable functionality.

Expansion unit	Software
MU368010A TDMA Modulation Unit	MX368011A PDC Software
	MX368012A GSM Device Test Software
MU368040A CDMA Modulation Unit	MX368041B W-CDMA Software
	MX368042A IS-95 Device Test Software
MU368030A Universal Modulation Unit	MX368031A Device Test Signal Generation Software
	MX368033A CDMA2000 1xEV-DO Signal Generation Software
	MX368034A PDC Packet Software
	MX368035A PHS Signal Generation Software
MU368060A AWGN Unit	-

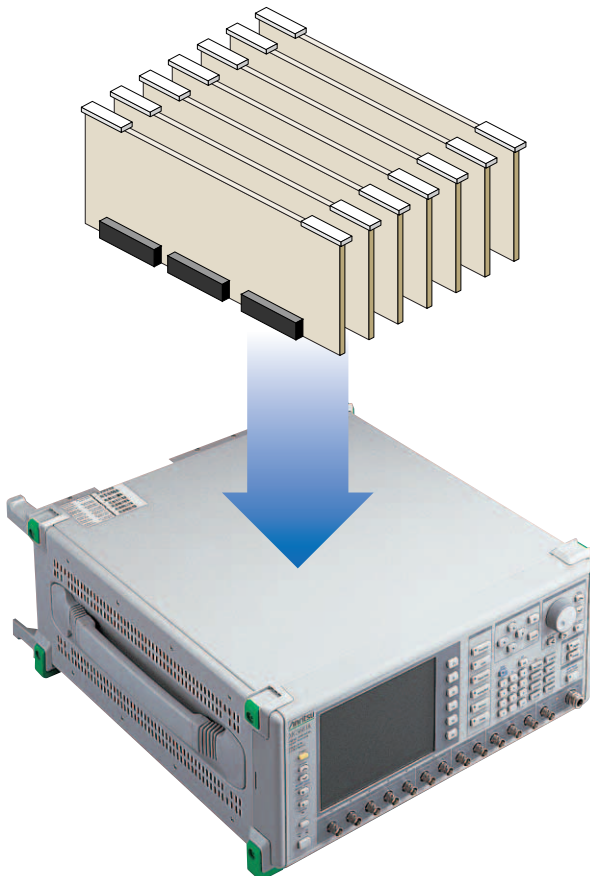

Excellent Adjacent Channel Leakage Power Ratio

The adjacent channel leakage power ratio of the digital modulation signal generator is an important factor in distortion testing of device and interference testing of receiver.

The MG3681A achieves an excellent adjacent channel leakage power ratio by an optimized circuit design. The typical adjacent channel leakage power ratio for W-CDMA system is -68 dBc/3.84 MHz and the secondary adjacent channel leakage power ratio is -75 dBc/3.84 MHz.

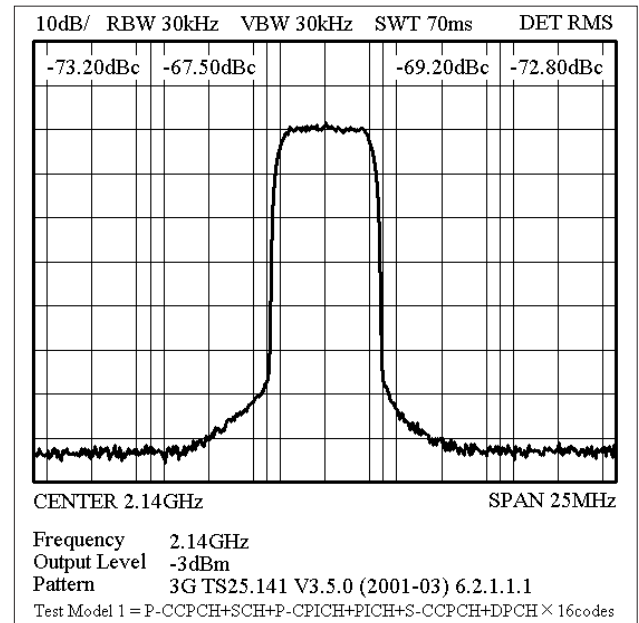

W-CDMA system adjacent channel leakage power ratio at 16 code multiplex

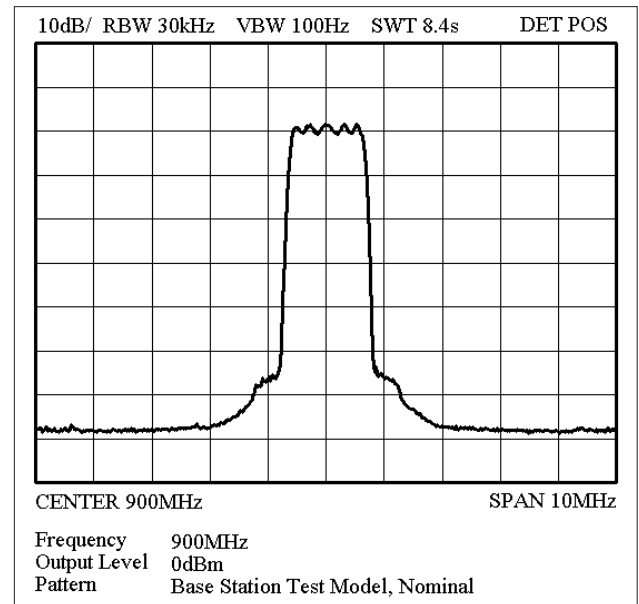

IS-95 system adjacent channel power ratio at 9 code multiplex

Excellent Operability

In order to realize the good operability is the important element in using signal generators, the operational flow has been analyzed. Parameters can be selected using the cursor keys and changed using either the ten-key pad,

rotary knob or step keys. The panel layout has been designed so that related operations can be performed smoothly and an easy-to-understand on-screen Help function facilitates the operation.

Digital Input Connectors

The auxiliary inputs for modulation differ according to the software to use. In order to help preventing connection mistakes, the functions and names of auxiliary input connectors are displayed according to the setting conditions.

Display

The color LCD makes it easy to understand the parameter types and edit selection status.

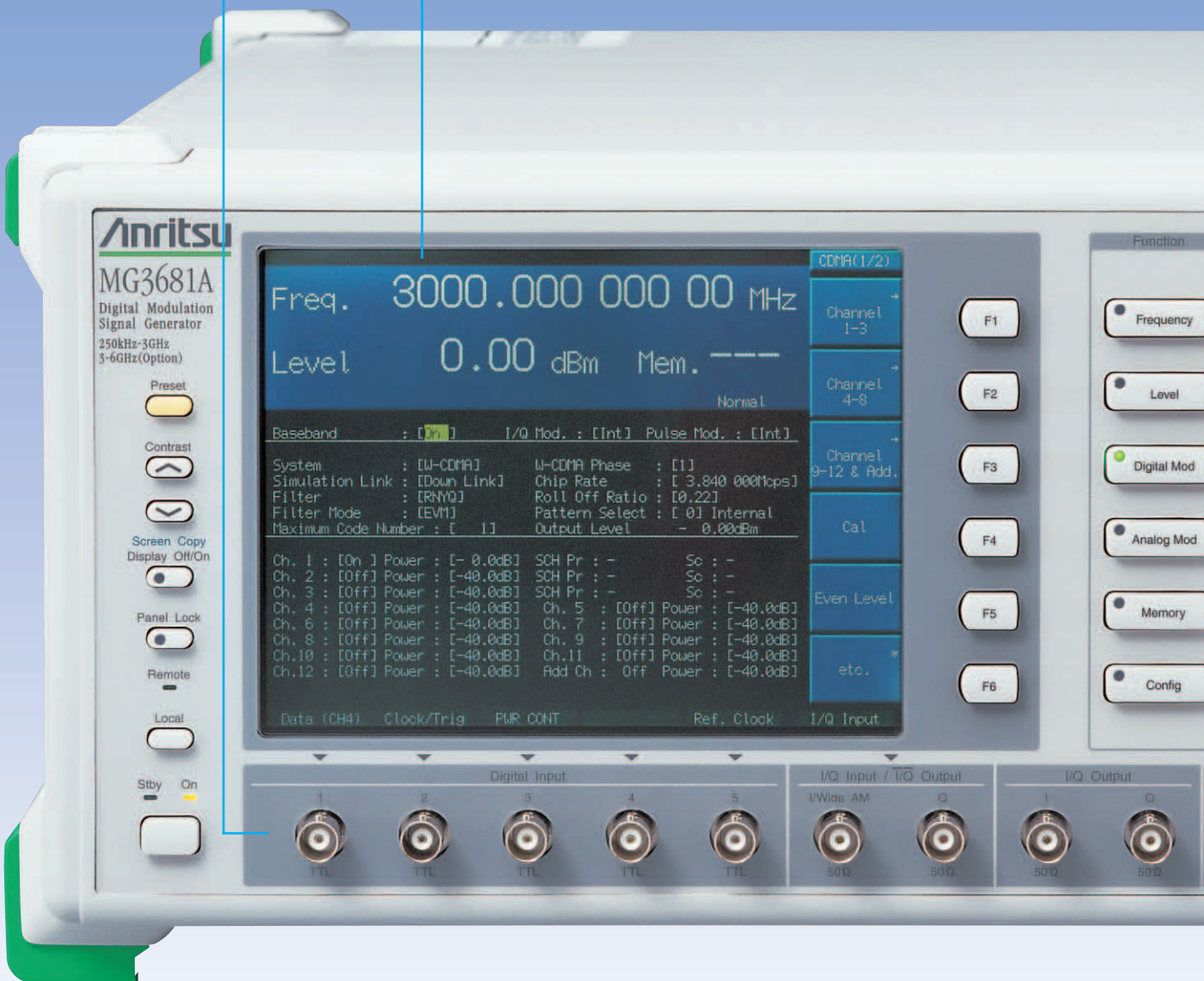

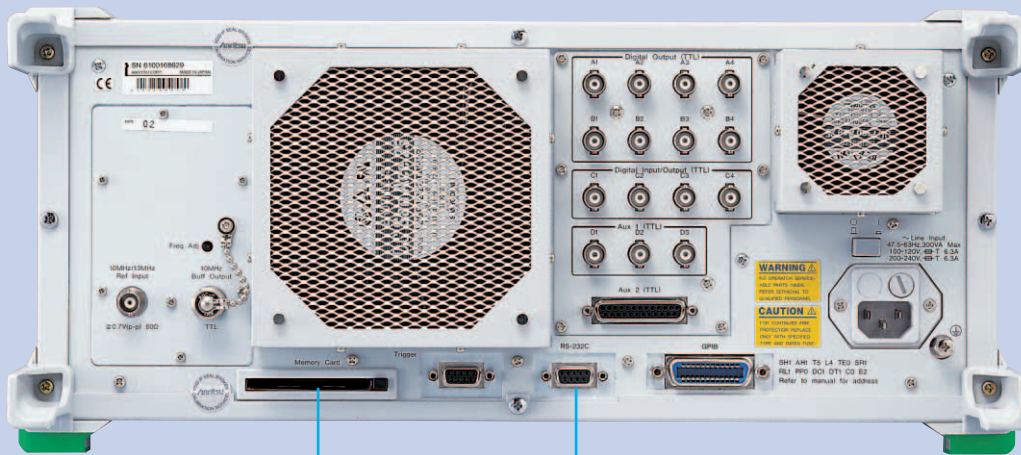

PC Card Slot

A PC card slot simplifies firmware upgrades and data downloads.

GPIO, RS-232C Interface

Remote control by both GPIB and RS-232C is supported. In addition, high-speed control, such as frequency increase and decrease, can be performed using TTL level signals.

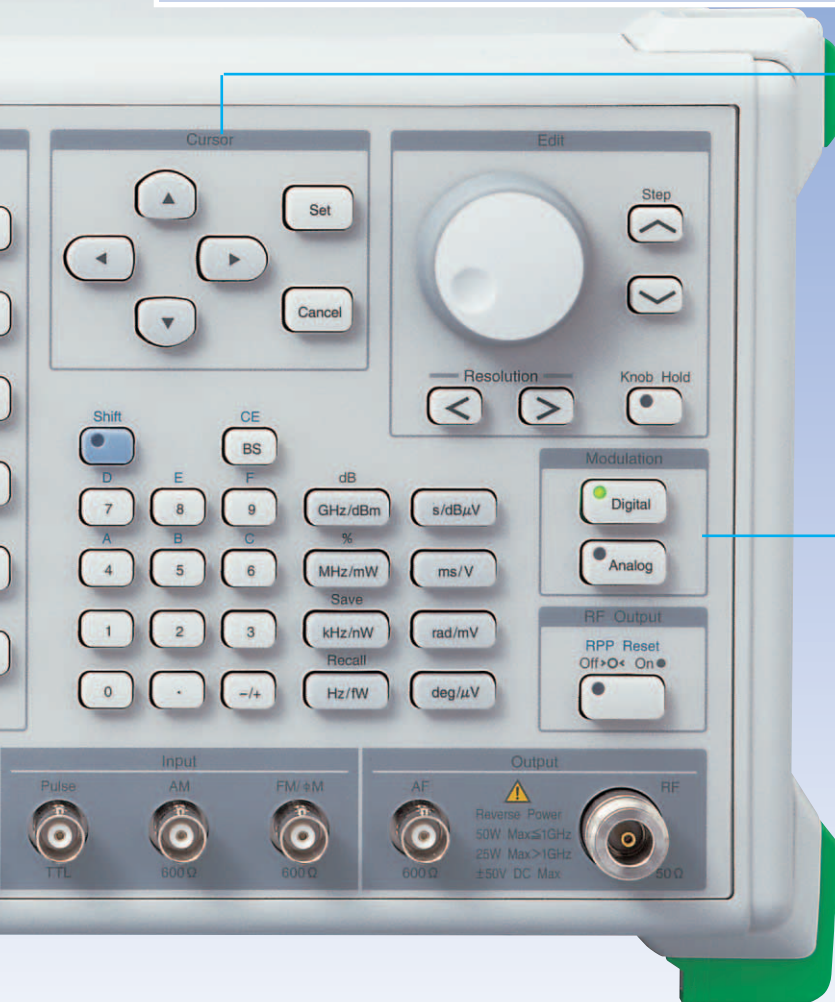

Cursor Keys

The cursor keys for selecting setting items have been arranged with consideration for good operability to permit efficient setting of many parameters. The setting method and setting range are different for each parameter, and are explained by on-screen Help display.

Modulation, RF Output ON/OFF key

The modulation and RF output can be switched on/off using one-touch keys.

Various Modulation Types

Digital Modulation

In addition to performing internal modulation using I/Q and burst signals generated by the expansion modulation units installed in the MG3681A, external modulation can also be performed using signals generated by an external baseband signal source. The expansion modulation unit operates irrespective of whether modulation is on or off and can be used as I/Q signals source. Moreover, when an optional additional function of I/Q output is installed, the I/Q signals amplitude and DC offset, etc., can be varied.

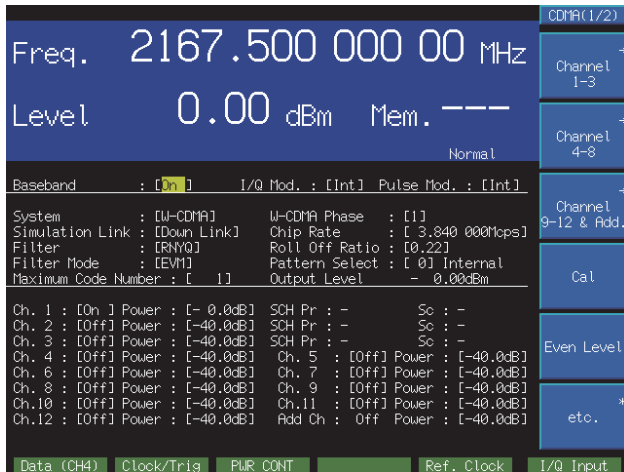

Digital modulation setting screen (when W-CDMA system selected)

Analog Modulation

AM, FM and ϕ M can be performed using an external modulation signal. When an optional AF synthesizer is installed, internal modulation at 0.01 Hz resolution with sine waves and triangular waves, etc., is also possible. The analog setting screen has been designed to provide an image of the modulation signal flow and greatly simplifies setting.



Analog modulation setting screen

Digital modulation signal flow

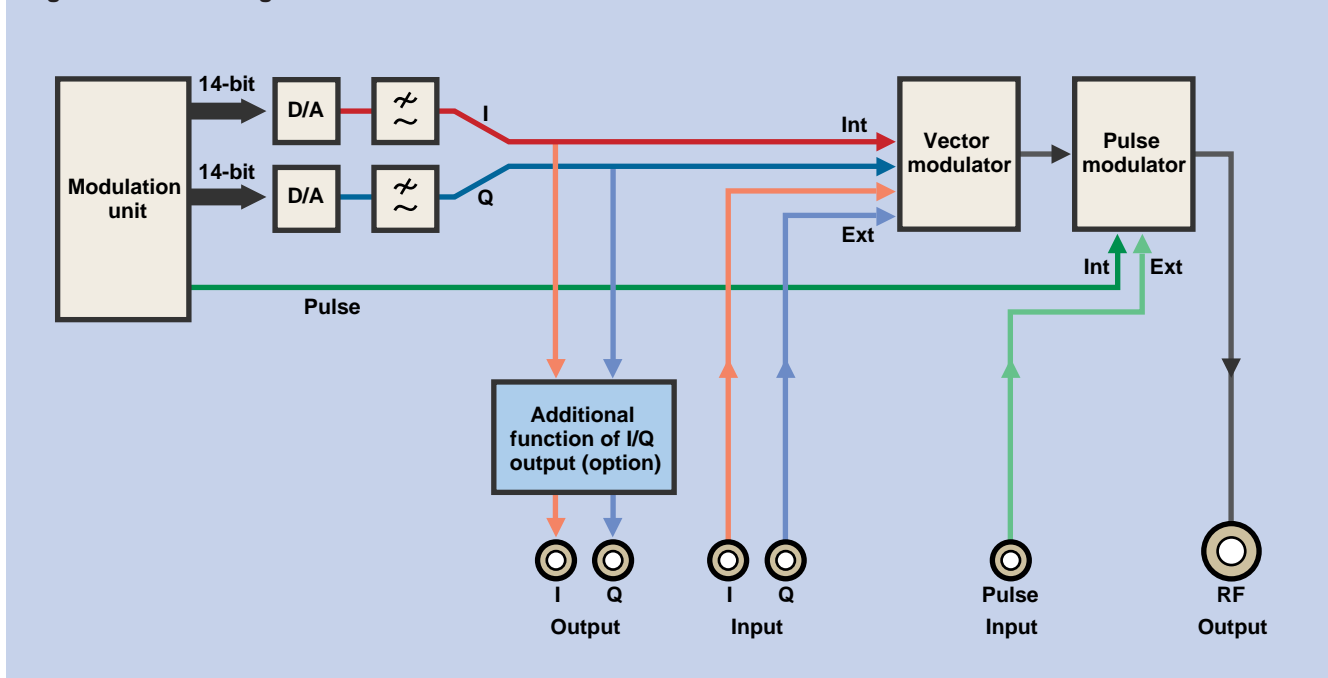

Full Function Lineup

High-resolution Output Level Setting of 0.01 dB

The output level can be set with a resolution of 0.01 dB across the entire level range. This is especially useful when wanting to set the level with a fine resolution for device tests, etc., as well as when calibrating the level with a standard such as a reference signal source or power meter, etc.



Output level display

Large Capacity Memory

Basic parameter memory can save up to 512 frequency and output level settings. All parameter memory can save up to 100 all settings including modulation settings. Basic parameter memory has a dedicated memory address display field that can be recalled continuously using the rotary knob or step keys. All parameter memory can be input titles up to 8-character length each, to make it easy to check the memory contents.



Basic parameter memory address display

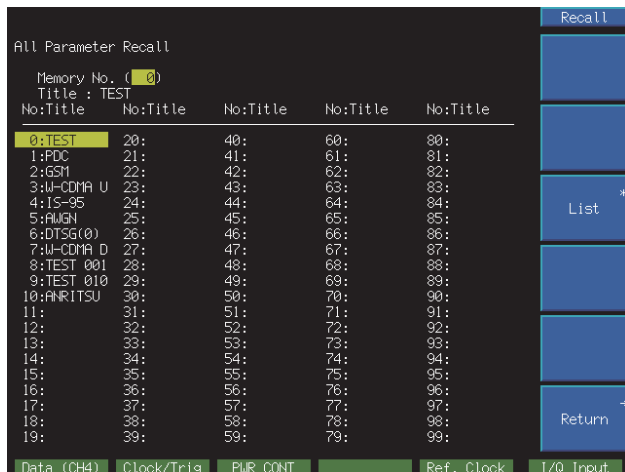

All parameter memory recall screen

Connector Function Name Display

The type of required auxiliary input signals for modulation varies with the used software. The functions according to the setting conditions are assigned to the auxiliary connectors. The function and name of each connector is displayed on the LCD to simplify the work of connecting other equipment and prevent connection mistakes.

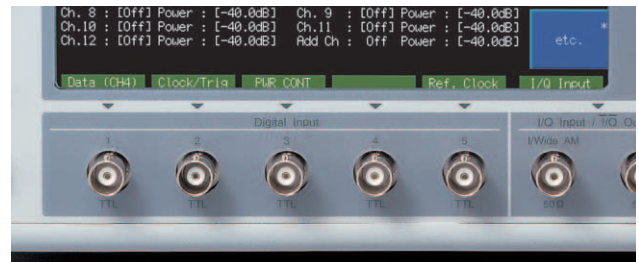

Example of front panel connector function display

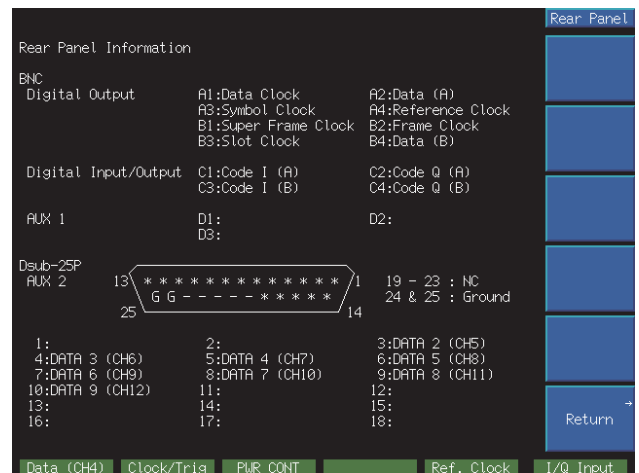

Example of rear panel connector function display

Operation Help Display

The parameters setting range and method are different at each item. The on-screen help for each setting range and method are displayed to simplify parameter operations in the setting window.



Example of help display when setting frequency offset

Specifications

MG3681A Main frame

Frequency	Range	250 kHz to 3000 MHz, Resolution: 0.01 Hz																		
	Accuracy	Depends on installed reference oscillator, Reference frequency accuracy: \pm (5% of FM setting deviation + 5 Hz) for frequency modulation																		
	Internal reference oscillator	Aging rate: $\pm 1 \times 10^{-6}$ /year, Temperature stability: $\pm 1 \times 10^{-6}$ (0° to 50°C)*1																		
	External reference input	10 MHz/13 MHz auto-switching, ± 10 ppm, ≥ 0.7 V(p-p)/50 Ω (AC coupled), BNC connector (rear panel)																		
	Buffer output	10 MHz, TTL level (DC coupled), BNC connector (rear panel)																		
	Switching time	≤ 20 ms (response time from final command to ± 500 Hz of set frequency on GPIB at CW, ALC on, except when setting frequency is crossing over 600 MHz and 1010 MHz)																		
Output level	Range	-143 to +13 dBm (settable range: -143 to +17 dBm)																		
	Unit	dBm, W, dB μ V, V (dB μ V, V selected terminate/open voltage display)																		
	Resolution	0.01 dB (dBm, dB μ V units), 3 digits (W, V units)																		
	Frequency response	± 1 dB (CW, ALC on, 0 dBm)																		
	Accuracy	CW, ALC on <table border="1" style="margin-left: 20px;"> <thead> <tr> <th rowspan="2">Level</th> <th colspan="2">Frequency</th> </tr> <tr> <th>≤ 1 GHz</th> <th>> 1 GHz</th> </tr> </thead> <tbody> <tr> <td>$\leq +13$ dBm, ≥ -127 dBm</td> <td>± 1 dB</td> <td>± 2 dB</td> </tr> <tr> <td>< -127 dBm</td> <td>± 2 dB</td> <td>± 3 dB</td> </tr> </tbody> </table>			Level	Frequency		≤ 1 GHz	> 1 GHz	$\leq +13$ dBm, ≥ -127 dBm	± 1 dB	± 2 dB	< -127 dBm	± 2 dB	± 3 dB					
	Level	Frequency																		
		≤ 1 GHz	> 1 GHz																	
	$\leq +13$ dBm, ≥ -127 dBm	± 1 dB	± 2 dB																	
	< -127 dBm	± 2 dB	± 3 dB																	
	Output connector	50 Ω , N-type connector (front panel)																		
Switching time	≤ 50 ms (normal mode), ≤ 100 ms (safety mode), ≤ 10 ms (continuous mode) *Response time from final command to ± 0.5 dB of final level on GPIB at CW, ALC on																			
Special setting mode	Continuous mode: Level continuously adjustable in set value range of ± 10 dB (dBm, dB μ V units only) For vector modulation by optional digital modulation unit, continuous mode variance depends on modulation setting Safety mode: Mechanical attenuator decreases level to prevent generation of high-level signal spikes																			
ALC mode	ALC on Usage: Continuous wave or pulse modulation wave (burst wave) with RF On time of 10 μ s or more ALC time constant: Auto, 500 ns, 2.4 μ s, 5 μ s, 24 μ s, 50 μ s, 240 μ s, 500 μ s selectable At Auto, automatically selected depending on frequency, AM and vector modulation [when digital modulation unit (option) is used] The ALC time constant is automatically selected, depending on the set frequency, regardless of the time constant selected on the front panel ALC off Usage: Pulse modulation wave (burst wave) whose RF on time is less than 10 μ s Restrict item: Without AM ALC calibration: Automatic during ALC Calibration operation and at frequency/level setting change																			
Signal purity	Spurious	Harmonics: < -30 dBc Non harmonic: <table border="1" style="margin-left: 20px;"> <thead> <tr> <th>Frequency</th> <th>15 kHz to 300 MHz offset</th> <th>> 300 MHz offset</th> <th>Fixed frequency spurious</th> </tr> </thead> <tbody> <tr> <td>≤ 2500 MHz</td> <td>< -60 dBc</td> <td>< -30 dBc</td> <td>-50 dBc (660, 1320 MHz)</td> </tr> <tr> <td>> 2500 MHz</td> <td colspan="2">< -30 dBc</td> <td>-</td> </tr> </tbody> </table>			Frequency	15 kHz to 300 MHz offset	> 300 MHz offset	Fixed frequency spurious	≤ 2500 MHz	< -60 dBc	< -30 dBc	-50 dBc (660, 1320 MHz)	> 2500 MHz	< -30 dBc		-				
		Frequency	15 kHz to 300 MHz offset	> 300 MHz offset	Fixed frequency spurious															
		≤ 2500 MHz	< -60 dBc	< -30 dBc	-50 dBc (660, 1320 MHz)															
> 2500 MHz	< -30 dBc		-																	
Power line and Fan rotation: < -40 dBc *CW, continuous mode: off, ≤ 0 dBm																				
SSB phase noise: < -118 dBc/Hz (≥ 10 MHz, ≤ 1010 MHz), < -112 dBc/Hz (> 1010 MHz) *At CW, 20 kHz offset																				
AM	Range	0 to 100% (cannot set internal/external modulation independently), Resolution: 0.1%																		
	Modulation frequency response	≤ 0 dBm, ALC on, in band of ± 1.5 dB based on modulation frequency of 1 kHz <table border="1" style="margin-left: 20px;"> <thead> <tr> <th rowspan="2">Frequency</th> <th rowspan="2">Lower limit frequency</th> <th colspan="2">Upper limit frequency</th> </tr> <tr> <th>Vector modulation and wideband AM off</th> <th>Vector modulation or wideband AM on</th> </tr> </thead> <tbody> <tr> <td>≥ 0.4 MHz, < 2 MHz</td> <td rowspan="3">DC (Internal modulation, External modulation DC coupled), 20 Hz (External modulation AC coupled)</td> <td>AM: 30%</td> <td>AM: 80%</td> </tr> <tr> <td>≥ 2 MHz, < 10 MHz</td> <td>3 kHz</td> <td>1 kHz</td> </tr> <tr> <td>≥ 10 MHz</td> <td>10 kHz</td> <td>10 kHz</td> </tr> </tbody> </table>			Frequency	Lower limit frequency	Upper limit frequency		Vector modulation and wideband AM off	Vector modulation or wideband AM on	≥ 0.4 MHz, < 2 MHz	DC (Internal modulation, External modulation DC coupled), 20 Hz (External modulation AC coupled)	AM: 30%	AM: 80%	≥ 2 MHz, < 10 MHz	3 kHz	1 kHz	≥ 10 MHz	10 kHz	10 kHz
	Frequency	Lower limit frequency	Upper limit frequency																	
			Vector modulation and wideband AM off	Vector modulation or wideband AM on																
	≥ 0.4 MHz, < 2 MHz	DC (Internal modulation, External modulation DC coupled), 20 Hz (External modulation AC coupled)	AM: 30%	AM: 80%																
	≥ 2 MHz, < 10 MHz		3 kHz	1 kHz																
≥ 10 MHz	10 kHz		10 kHz																	
Internal modulation	requires AF synthesizer (Option 21)																			
External modulation	2 V(p-p) approx., 600 Ω , AC/DC coupled switchable, BNC connector (front panel)																			
Modulation signal polarity	Positive/negative switchable																			

FM	Range	0 to 1000 kHz (≥ 10 MHz, ≤ 1010 MHz), 0 to 2000 kHz (> 1010 MHz) *Cannot set internal/external modulation independently.
	Resolution	10 Hz (0 to 10 kHz deviation), 100 Hz (10.1 to 100 kHz deviation), 1 kHz (101 to 1000 kHz deviation), 10 kHz (1010 to 2000 kHz deviation)
	Modulation frequency response	DC to 20 kHz (internal modulation, external modulation DC coupled), 20 Hz to 20 kHz (external modulation AC coupled) *In band of ± 1 dB based on modulation frequency of 1 kHz
	Internal modulation	requires AF synthesizer (Option 21)
	External modulation	2 V(p-p) approx., 600 Ω , AC/DC coupled switchable, BNC connector (front panel)
	Modulation signal polarity	Positive/negative switchable
ϕ M	Range	0 to 6.28 rad (≥ 10 MHz, ≤ 1010 MHz), 0 to 12.56 rad (> 1010 MHz) *Cannot set internal/external modulation independently.
	Unit	rad, deg
	Resolution	rad unit: 0.01 rad, deg unit: 1 deg
	Modulation frequency response	DC to 20 kHz (internal modulation, external modulation DC coupled), 20 Hz to 20 kHz (external modulation AC coupled) *In band of ± 1 dB based on modulation frequency of 1 kHz
	Internal modulation	requires AF synthesizer (Option 21)
	External modulation	2 V(p-p) approx., 600 Ω , AC/DC coupled switchable, BNC connector (front panel)
Wideband AM	Modulation frequency response	DC to 15 MHz (± 2 dB bandwidth), DC to 30 MHz (± 3 dB bandwidth) *External modulation, input level: 0.9 V(p-p), ≥ 100 MHz, ≤ 0 dBm, modulation frequency of 1 kHz
	Internal modulation	requires digital modulation unit (option)
	External modulation	≤ 1 V(p-p), 50 Ω , BNC connector (front panel), sensitivity: 1 V(p-p) = 100%
Pulse modulation	On/off ratio	> 60 dB
	Rise/fall time	< 100 ns (external modulation)
	Minimum pulse width	< 500 ns (external modulation)
	Pulse repetition frequency	DC to 1 MHz (external modulation, ALC off)
	Internal modulation	requires digital modulation unit (option)
	External modulation	TTL level, positive logic, 50 Ω , BNC connector (front panel)
Vector modulation	Modulation frequency response	DC to 15 MHz (± 2 dB bandwidth), DC to 30 MHz (± 3 dB bandwidth) *External modulation, input level: 0.5 V(rms), ≥ 100 MHz, ≤ 0 dBm, modulation frequency of 1 kHz
	Vector error	$\leq 2.5\%$ (rms) [External modulation, input level: 0.5 V(rms), ≥ 100 MHz, ≤ 0 dBm, 3.84 Msps QPSK modulation]
	Internal modulation	requires digital modulation unit (option)
	External modulation	$\sqrt{I^2 + Q^2} = 0.5$ V(rms), $I/Q = \pm 1.5$ V(peak), 50 Ω , BNC connector (front panel)
	Quadrature degree adjustment function	Adjustment range: $\geq \pm 1$ deg
	I/Q change	I, Q signal changeable (RF spectrum invert)
Simultaneous modulation		Modulation depth and deviation same for combinations below: AM (internal/external), FM (internal/external), ϕ M (internal/external) Frequency and waveform of modulation signal source same for combinations below: AM (internal)/FM (internal), AM (internal)/ ϕ M (internal) Simultaneous modulation impossible as below: FM/ ϕ M, wideband AM/vector modulation, vector (internal)/Vector (external) modulation
AF signal output		requires AF synthesizer (Option 21)
I/Q signal output*2	Output level	requires digital modulation unit (option)
	Output signal source	requires digital modulation unit (option)
	Output connector	50 Ω , BNC connector (front panel)
Memory function	Basic parameter memory	512 sets of frequency and level
	All parameter memory	All parameters including 100 sets maximum of analog modulation and digital modulation units (option)
Sweep function	Sweep parameter	Basic parameter memory address
	Sweep pattern	Start address \rightarrow stop address
	Sweep time	1 ms to 600 s (per memory; memory recall time restricts lower limit, resolution: 1 ms)
Special display	Sweep mode	Auto (repetition sweep), single (single sweep)
	Relative display	Frequency, output level (dBm, dB μ V units only)
Display	Offset display	Frequency (offset range: -3 to $+3$ GHz), output level (offset range: -50 to $+50$ dB, dBm, dB μ V units only)
	Size	7.2 inch, 480 x 640 dots, color D-STN
Backup function	On/off setting	Panel display on/off
		All items reset at power-on except following: Input data contents, remote condition, contents of GPIB data being transferred, RPP operation condition, screen condition, main function selections

Panel lock function	Panel lock	Disable operation of all keys except front panel power key, panel lock key, local key and contrast key
	Knob hold	Disable rotary knob on front panel operation
External interface	GPIB	Remote control: All functions except power switch, local key, and contrast key Interfaces: SH1, AH1, T5, L4, TE0, SR1, RL1, DP0, PP0, DC1, DT1, C1, E2 Connector: Rear panel
	RS-232C	Remote control: All functions except power switch, local key, and contrast key Communications method: Async (start-stop), half-duplex Communications control method: X on/off by command Baud rate: 1200, 2400, 4800, 9600, 19200, 38400 bps Data bits; 7 or 8 Parity: Odd, even, none Start bit; 1 Stop bit: 1 or 2 Connector: D-sub 9 pins, rear panel
	PC card	Memory card (memory backup, screen hard copy) Connector: JEIDA Ver 4/4.1 PCMCIA Rel 2.0, 1 slot (rear panel)
	Trigger	Executes item specified by command-input signals (3 bits) from following items: Frequency step-up/step-down, output level step-up/step-down, basic parameter memory recall address up/down, output level on/off Interface: TTL level Connector: D-sub 9-pin, female (rear panel)
Reverse power protection	≤50 W (≤1 GHz), ≤25 W (>1 GHz), ±50 V (DC)	
Power	AC 100 to 120/200 to 240 V (-15/+10%, 250 V max, automatic selection), 47.5 to 63 Hz, ≤300 VA	
Temperature	Operating: 0° to 50°C, Storage: -20° to +60°C	
Dimensions and mass	426 (W) x 177 (H) x 451 (D) mm, ≤25 kg (excluding option)	
EMC	EN61326: 1997/A2: 2001 (Class A) EN61000-3-2: 2000 (Class A) EN61326: 1997/A2: 2001 (Annex A)	
LVD	EN61010-1: 2001 (Pollution Degree 2)	

*1: Aging rates down to 5×10^{-10} /day are available as reference crystal oscillator (MG3681A Option 01/02).

*2: Possible to expand the function with MG3681A Option 11

Options

<p>Option 01 (Reference crystal oscillator)</p>	<p>Frequency: 10 MHz Aging rate: $\pm 5 \times 10^{-9}$/day Start-up characteristics: 1×10^{-7} (After 10 min, compared to frequency after 24 h warm-up) Temperature stability: $\pm 3 \times 10^{-8}$ (0° to 50°C)</p>
<p>Option 02 (Reference crystal oscillator)</p>	<p>Frequency: 10 MHz Aging rate: $\pm 5 \times 10^{-10}$/day Start-up characteristics: 1×10^{-7} (After 10 min, compared to frequency after 24 h warm-up) Temperature stability: $\pm 5 \times 10^{-9}$ (0 to 50°C)</p>
<p>Option 11 (Additional function of I/Q output)</p>	<p>Functions: Adds level, offset setting, and differential output functions to I/Q output Level Range: 80 to 120% of nominal level, Resolution: 0.1% *2 sets of I/\bar{I} and Q/\bar{Q} set independently, 50 Ω termination Offset Range: -0.5 to +1.5 V, Resolution: 0.5 mV *4 sets of I, \bar{I}, Q, \bar{Q} set independently, 50 Ω termination Quadrature degree variable function Range: ± 5 deg, Resolution: 0.5 deg Differential output: \bar{I}, \bar{Q} signals (Using front I/Q input connector) Signal source: Depends on installed digital modulation unit (option) Output connector: 50 Ω, BNC connector (front panel)</p>
<p>Option 21 (AF synthesizer)</p>	<p>Frequency: 0.01 Hz to 400 kHz, Resolution: 0.01 Hz, Accuracy: same as reference oscillator Waveform: Sine, triangular, square, sawtooth Frequency response: ± 1 dB [sine wave, level: 2 V(p-p), offset: 0 V, 600 Ω termination, reference to 1 kHz, 10 Hz to 100 kHz] Harmonics: ≤ -50 dB [sine wave, level: 2 V(p-p), offset: 0 V, 600 Ω termination, 1 kHz] Level Range: 0 to 4 V(p-p), Resolution: 1 mV(p-p), Accuracy: \pm [8% of set level + 2 mV(p-p)] *600 Ω termination Offset Range: -2 to +2 V, Resolution: 1 mV, Accuracy: \pm (8% of set level + 2 mV) *600 Ω termination Output connector: 600 Ω, BNC connector (front panel)</p>
<p>Option 42 (RF high level output)</p>	<p>Functions: 8 dB gain of maximum output level Frequency: 1900 to 2300 MHz Gain: 8 ± 1 dB (from -3 dBm, RF high level output off, 2.1 GHz) Gain frequency response: ± 1 dB (at +5 dBm, referenced to 2.1 GHz)</p>

Ordering Information

Please specify the model/order number, name, and quantity when ordering.

Model/Order No.	Name	Remarks
MG3681A	Main frame Digital Modulation Signal Generator	
	Standard accessories	
	Power cord, 2.6 m: 1 pc	
B0325	GPIB connector shield cap: 1 pc	
F0014	Fuse, 6.3 A: 2 pcs	
W1708AE	MG3681A operation manual: 1 copy	
	Options	
MG3681A-01	Reference oscillator	Aging rate: 5×10^{-9} /day
MG3681A-02	Reference oscillator	Aging rate: 5×10^{-10} /day
MG3681A-11	Additional function of I/Q output	Level and DC offset setting, differential output
MG3681A-21	AF synthesizer	0.01 Hz to 400 kHz, resolution: 0.01 Hz
MG3681A-42	RF high level output	8 dB gain
	Maintenance service	
MG3681A-90	Extended three years warranty service	
MG3681A-91	Extended five years warranty service	
	Expansion unit	
MU368010A	TDMA Modulation Unit*1,*2	
MU368030A	Universal Modulation Unit*1,*2	
MU368040A	CDMA Modulation Unit*1,*2	
MU368060A	AWGN Unit*2	
	Softwares	
MX368011A	PDC Software*2	For MU368010A
MX368012A	GSM Device Test Software*2	For MU368010A
MX368031A	Device Test Signal Generation Software*2	For MU368030A
MX368033A	CDMA2000 1xEV-DO Signal Generation Software	For MU368030A
MX368034A	PDC Packet Software	For MU368030A
MX368035A	PHS Signal Generation Software	For MU368030A
MX368041B	W-CDMA Software*2	For MU368040A
MX368041B-11	HSDPA Signal Pattern	
MX368042A	IS-95 Device Test Software*2	For MU368040A
	Application parts	
J0576B	Coaxial cord (N-P • 5D-2W • N-P), 1 m	
J0576D	Coaxial cord (N-P • 5D-2W • N-P), 2 m	
J0127C	Coaxial cord (BNC-P • RG-58A/U • BNC-P), 0.5 m	
J0127A	Coaxial cord (BNC-P • RG-58A/U • BNC-P), 1 m	
J0007	GPIB connection cable, 1 m	
J0008	GPIB connection cable, 2 m	
B0329C	Front cover (1MW4U)	
B0331C	Front-panel handle kit	2 pcs/set
B0332	Joint plate	4 pcs/set
B0333C	Rack mount kit	
B0334C	Carrying case	Hard type, with front cover and casters
MA2512A	Band Pass Filter*2	For W-CDMA, pass band: 1.92 to 2.17 GHz

*1: When using the MU368010A, MU368030A and MU368040A, dedicated software must be installed.

*2: Refer to the data sheets for the expansion units, software and Band pass filter.

Notes:



Specifications are subject to change without notice.

ANRITSU CORPORATION

1800 Onna, Atsugi-shi, Kanagawa, 243-8555 Japan
Phone: +81-46-223-1111
Fax: +81-46-296-1264

● **U.S.A.**

ANRITSU COMPANY

TX OFFICE SALES AND SERVICE

1155 East Collins Blvd., Richardson, TX 75081, U.S.A.
Toll Free: 1-800-ANRITSU (267-4878)
Phone: +1-972-644-1777
Fax: +1-972-644-3416

● **Canada**

ANRITSU ELECTRONICS LTD.

700 Silver Seven Road, Suite 120, Kanata,
ON K2V 1C3, Canada
Phone: +1-613-591-2003
Fax: +1-613-591-1006

● **Brazil**

ANRITSU ELETRÔNICA LTDA.

Praca Amadeu Amaral, 27 - 1 andar
01327-010 - Paraiso, Sao Paulo, Brazil
Phone: +55-11-3283-2511
Fax: +55-11-3886940

● **U.K.**

ANRITSU LTD.

200 Capability Green, Luton, Bedfordshire LU1 3LU, U.K.
Phone: +44-1582-433280
Fax: +44-1582-731303

● **Germany**

ANRITSU GmbH

Grafenberger Allee 54-56, 40237 Düsseldorf, Germany
Phone: +49-211-96855-0
Fax: +49-211-96855-55

● **France**

ANRITSU S.A.

9, Avenue du Québec Z.A. de Courtabœuf 91951 Les
Ulis Cedex, France
Phone: +33-1-60-92-15-50
Fax: +33-1-64-46-10-65

● **Italy**

ANRITSU S.p.A.

Via Elio Vittorini, 129, 00144 Roma EUR, Italy
Phone: +39-06-509-9711
Fax: +39-06-502-2425

● **Sweden**

ANRITSU AB

Fagelviksvagen 9E S145 84 Stockholm, Sweden
Phone: +46-853470700
Fax: +46-853470730

● **Singapore**

ANRITSU PTE LTD.

10, Hoe Chiang Road #07-01/02, Keppel Towers,
Singapore 089315
Phone: +65-6282-2400
Fax: +65-6282-2533

● **Hong Kong**

ANRITSU COMPANY LTD.

Suite 923, 9/F., Chinachem Golden Plaza, 77 Mody
Road, Tsimshatsui East, Kowloon, Hong Kong, China
Phone: +852-2301-4980
Fax: +852-2301-3545

● **P. R. China**

ANRITSU COMPANY LTD.

Beijing Representative Office

Room 1515, Beijing Fortune Building, No. 5 North Road,
the East 3rd Ring Road, Chao-Yang District
Beijing 100004, P.R. China
Phone: +86-10-6590-9230

● **Korea**

ANRITSU CORPORATION

8F Hyun Juk Bldg, 832-41, Yeoksam-dong,
Kangnam-ku, Seoul, 135-080, Korea
Phone: +82-2-553-6603
Fax: +82-2-553-6604

● **Australia**

ANRITSU PTY LTD.

Unit 3/170 Forster Road Mt. Waverley, Victoria, 3149,
Australia
Phone: +61-3-9558-8177
Fax: +61-3-9558-8255

● **Taiwan**

ANRITSU COMPANY INC.

7F, No. 316, Sec. 1, NeiHu Rd., Taipei, Taiwan
Phone: +886-2-8751-1816
Fax: +886-2-8751-1817

031113